

Satellite[®] 3000/3005 Series User's Guide

If you need assistance:



- ❖ VirtualTech[™] e-support tool
Double-click the desktop icon or visit the Web site:
<http://virtualtech.answersteam.com>
- ❖ InTouchsm Center
Calling within the United States (800) 457-7777
Calling from outside the United States (949) 859-4273

For more information, see [Chapter 8 on page 185](#) in this guide.

Model: Satellite 3000/3005 Series

Compact Disk-ReWritable

The computer system you purchased may include a Compact Disk-Rewritable (CD-RW), one of the most advanced storage technologies available. As with any new technology, you must read and follow all set-up and usage instructions in the applicable user guides and/or manuals enclosed. If you fail to do so, this product may not function properly and you may lose data or suffer other damage.

TOSHIBA AMERICA INFORMATION SYSTEMS (“TOSHIBA”), ITS AFFILIATES AND SUPPLIERS DO NOT WARRANT THAT OPERATION OF THE PRODUCT WILL BE UNINTERRUPTED OR ERROR FREE. YOU AGREE THAT TOSHIBA, ITS AFFILIATES AND SUPPLIERS SHALL HAVE NO RESPONSIBILITY FOR DAMAGE TO OR LOSS OF ANY BUSINESS, PROFITS, PROGRAMS, DATA OR REMOVABLE STORAGE MEDIA ARISING OUT OF OR RESULTING FROM THE USE OF THE PRODUCT, EVEN IF ADVISED OF THE POSSIBILITY THEREOF.

Protection of Stored Data

For your important data, please make periodic back-up copies of all the data stored on the hard disk or other storage devices as a precaution against possible failures, alteration, or loss of the data. **IF YOUR DATA IS ALTERED OR LOST DUE TO ANY TROUBLE, FAILURE OR MALFUNCTION OF THE HARD DISK DRIVE OR OTHER STORAGE DEVICES AND THE DATA CANNOT BE RECOVERED, TOSHIBA SHALL NOT BE LIABLE FOR ANY DAMAGE OR LOSS OF DATA, OR ANY OTHER DAMAGE RESULTING THEREFROM. WHEN COPYING OR TRANSFERRING YOUR DATA, PLEASE BE SURE TO CONFIRM WHETHER THE DATA HAS BEEN SUCCESSFULLY COPIED OR TRANSFERRED. TOSHIBA DISCLAIMS ANY LIABILITY FOR THE FAILURE TO COPY OR TRANSFER THE DATA CORRECTLY.**

Critical Applications

The computer you have purchased is not designed for any “critical applications.” “Critical applications” means life support systems, medical applications, connections to implanted medical devices, commercial transportation, nuclear facilities or systems or any other applications where product failure could lead to injury to persons or loss of life or catastrophic property damage.

ACCORDINGLY, TOSHIBA, ITS AFFILIATES AND SUPPLIERS DISCLAIM ANY AND ALL LIABILITY ARISING OUT OF THE USE OF THE COMPUTER PRODUCTS IN ANY CRITICAL APPLICATIONS. IF YOU USE THE COMPUTER PRODUCTS IN A CRITICAL APPLICATION, YOU, AND NOT TOSHIBA, ASSUME FULL RESPONSIBILITY FOR SUCH USE.

FCC Notice

This equipment has been tested and found to comply with the limits for a Class B digital device, pursuant to Part 15 of the FCC rules. These limits are designed to provide reasonable protection against harmful interference in a residential installation.

This equipment generates, uses and can radiate radio frequency energy and, if not installed and used in accordance with the instructions, it may cause harmful interference to radio communications. However, there is no guarantee that interference will not occur in a particular installation. If this equipment does cause harmful interference to radio or television reception, which can be determined by turning the equipment off and on, the user is encouraged to try to correct the interference by one or more of the following measures:

- ❖ Reorient or relocate the receiving antenna.
- ❖ Increase the separation between the equipment and receiver.
- ❖ Connect the equipment to an outlet on a circuit different from that to which the receiver is connected.
- ❖ Consult the dealer or an experienced radio/TV technician for help.



NOTE: Only peripherals complying with the FCC Class B limits may be attached to this computer. Operation with non-compliant peripherals or peripherals not recommended by Toshiba is likely to result in interference to radio and TV reception. Shielded cables must be used between the external devices and the computer's parallel port, monitor port, USB port, and microphone jack. Changes or modifications made to this equipment not expressly approved by Toshiba or parties authorized by Toshiba could void the user's authority to operate the equipment.

This device complies with Part 15 of the FCC Rules. Operation is subject to the following two conditions:

- ❖ This device may not cause harmful interference.

- ❖ This device must accept any interference received, including interference that may cause undesired operation.

Contact:

Toshiba America Information Systems, Inc.
9740 Irvine Blvd.
Irvine, CA 92618-1697
(949) 583-3000

Industry Canada requirement

This Class B digital apparatus complies with Canadian ICES-003.

Cet appareil numérique de la classe B est conforme à la norme NMB-003 du Canada.

FCC requirements

The following information is pursuant to FCC CFR 47, Part 68 and refers to internal modems.

Installation

When you are ready to install or use the modem, call your local telephone company and give them the following information:

- ❖ The telephone number of the line to which you will connect the modem.
- ❖ The FCC registration number of the modem.
- ❖ The Ringer Equivalence Number (REN) of the modem, which is 0.9B.

The modem connects to the telephone line by means of a standard jack called the USOC RJ11C.

Type of service

Your modem is designed to be used on standard-device telephone lines. Connection to telephone company-provided coin service (central office implemented systems) is prohibited. Connection to party lines service is subject to State tariffs. If you have any questions about your telephone line, such as how many pieces of equipment you can connect to it, the telephone company will provide this information upon request.

Telephone company procedures

The goal of the telephone company is to provide you with the best service it can. In order to do this, it may occasionally be necessary for them to make changes in their equipment, operations or procedures. If these changes might affect your service or the operation of your equipment, the telephone company will give you notice, in writing, to allow you to make any changes necessary to maintain uninterrupted service.

If problems arise

If any of your telephone equipment is not operating properly, you should immediately remove it from your telephone line, as it may cause harm to the telephone network. If the telephone company notes a problem, they may temporarily discontinue service. When practical, they will notify you in advance of this disconnection. If advance notice is not feasible, you will be notified as soon as possible. When you are notified, you will be given the opportunity to correct the problem and informed of your right to file a complaint with the FCC. In the event repairs are ever needed on your modem, they should be performed by Toshiba Corporation, Toshiba American Information Systems, Inc. or an authorized representative of Toshiba.

Disconnection

If you should ever decide to permanently disconnect your modem from its present line, please call the telephone company and let them know of this change.

Fax branding

The Telephone Consumer Protection Act of 1991 makes it unlawful to use a computer or other electronic device to send any message via a telephone fax machine unless such message clearly contains in a margin at the top or bottom of each transmitted page or on the first page of the transmission, the date and time it is sent and an identification of the business, other entity or individual sending the message and the telephone number of the sending machine or such business, other entity or individual.

In order to program this information into your fax modem, you should complete the setup for your fax software before sending a message.

Instructions for IC CS-03 certified equipment

- 1 **NOTICE:** The Industry Canada label identifies certified equipment. This certification means that the equipment meets certain telecommunications network protective, operational and safety requirements as prescribed in the appropriate Terminal Equipment Technical Requirements document(s). The Department does not guarantee the equipment will operate to the user's satisfaction.

Before installing this equipment, users should ensure that it is permissible to be connected to the facilities of the local telecommunications company. The equipment must also be installed using an acceptable method of connection. The customer should be aware that compliance with the above conditions may not prevent degradation of service in some situations.

Repairs to certified equipment should be coordinated by a representative designated by the supplier. Any repairs or alterations made by the user to this equipment, or equipment malfunctions, may give the telecommunications company cause to request the user to disconnect the equipment.

Users should ensure for their own protection that the electrical ground connections of the power utility, telephone lines and internal metallic water pipe system, if present, are connected together. This precaution may be particularly important in rural areas.

Caution: Users should not attempt to make such connections themselves, but should contact the appropriate electric inspection authority, or electrician, as appropriate.

- 2 The user manual of analog equipment must contain the equipment's Ringer Equivalence Number (REN) and an explanation notice similar to the following:

The Ringer Equivalence Number (REN) of this device is 0.4B.

NOTICE: The Ringer Equivalence Number (REN) assigned to each terminal device provides an indication of the maximum number of terminals allowed to be connected to a telephone interface. The termination on an interface may consist of any combination of devices subject only to the requirement that the sum of the Ringer Equivalence Numbers of all the devices does not exceed 5.

- 3 The standard connecting arrangement (telephone jack type) for this equipment is jack type(s): USOC RJ11C.

Wireless Interoperability

The Toshiba Wireless LAN Mini PCI Card products are designed to be interoperable with any wireless LAN product that is based on Direct Sequence Spread Spectrum (DSSS) radio technology, and is compliant to:

- ❖ The IEEE 802.11 Standard on Wireless LANs (Revision B), as defined and approved by the Institute of Electrical and Electronics Engineers.
- ❖ The Wireless Fidelity (Wi-Fi™) certification as defined by the WECA Wireless Ethernet Compatibility Alliance.

Wireless LAN and your Health

Wireless LAN products, like other radio devices, emit radio frequency electromagnetic energy. The level of energy emitted by Wireless LAN devices however is far much less than the electromagnetic energy emitted by wireless devices like for example mobile phones. Because Wireless LAN products operate within the guidelines found in radio frequency safety standards and recommendations, Toshiba believes Wireless LAN is safe for use by consumers. These standards and recommendations reflect the consensus of the scientific community and result from deliberations of panels and committees of scientists who continually review and interpret the extensive research literature.

In some situations or environments, the use of Wireless LAN may be restricted by the proprietor of the building or responsible representatives of the organization. These situations may for example include:

- ❖ Using the Wireless LAN equipment on board of airplanes, or
- ❖ In any other environment where the risk of interference to other devices or services is perceived or identified as harmful.

If you are uncertain of the policy that applies on the use of wireless devices in a specific organization or environment (e.g., airports), you are encouraged to ask for authorization to use the Wireless LAN device prior to turning on the equipment.

Regulatory Information

The Toshiba Wireless LAN Mini PCI Card must be installed and used in strict accordance with the manufacturer's instructions as described in the user documentation that comes with the product. This device complies with the following radio frequency and safety standards.

Canada – Industry Canada (IC)

This device complies with RSS 210 of Industry Canada.

Operation is subject to the following two conditions: (1) this device may not cause interference, and (2) this device must accept any interference, including interference that may cause undesired operation of this device.

USA-Federal Communications Commission (FCC)

This device complies with Part 15 of FCC Rules. Operation of the devices in a Wireless LAN System is subject to the following two conditions:

- ❖ This device may not cause harmful interference.
- ❖ This device must accept any interference that may cause undesired operation.

Caution: Exposure to Radio Frequency Radiation

The radiated output power of the Toshiba Wireless LAN Mini PCI Card is far below the FCC radio frequency exposure limits. Nevertheless, the Toshiba Wireless LAN Mini PCI Card shall be used in such a manner that the potential for human contact during normal operation is minimized. When using this device in combination with other wireless LAN products, a certain separation distance between antenna and nearby persons has to be kept to ensure RF exposure compliance. The distance between the antennas and the user should not be less than 5.0 cm.

Refer to the Regulatory Statements as identified in the documentation that comes with those products for additional information.

The Toshiba Wireless LAN Mini PCI Card is far below the FCC radio frequency exposure limits.

Nevertheless, it is advised to use the Toshiba Wireless LAN Mini PCI Card in such a manner that human contact during normal operation is minimized.

Interference Statement

This equipment has been tested and found to comply with the limits for a Class B digital device, pursuant to Part 15 of the FCC Rules. These limits are designed to provide reasonable protection against harmful interference in a residential installation. This equipment generates, uses, and can radiate radio frequency energy. If not installed and used in accordance with the instructions, it may cause harmful interference to radio communications. However, there is no guarantee that interference will not occur in a particular installation.

If this equipment does cause harmful interference to radio or television reception, which can be determined by turning the equipment off and on, the user is encouraged to try and correct the interference by one or more of the following measures:

- ❖ Reorient or relocate the receiving antenna.
- ❖ Increase the distance between the equipment and the receiver.
- ❖ Connect the equipment to an outlet on a circuit different from that to which the receiver is connected.
- ❖ Consult the dealer or an experienced radio/TV technician for help.

Toshiba is not responsible for any radio or television interference caused by unauthorized modification of the devices included with this Toshiba Wireless LAN Mini PCI Card, or the substitution or attachment of connecting cables and equipment other than specified by Toshiba.

The correction of interference caused by such unauthorized modification, substitution or attachment will be the responsibility of the user.

Approved Countries for use

This equipment is approved to the radio standard by the countries in Fig.1.

Australia	Austria	Belgium
Canada	Denmark	Finland
Germany	Iceland	Ireland
Japan	Luxembourg	Netherlands
New Zealand	Norway	Sweden
Switzerland	UK	USA
Greece	Italy	France
Poland	Portugal	Spain

Caution: Do not use this equipment except in the countries in Fig 1.

CD-ROM, DVD-ROM, DVD-ROM/CD-RW Safety Instructions

The CD-ROM, DVD-ROM, and DVD-ROM/CD-RW drives employ a laser system. To ensure proper use of this product, please read this instruction manual carefully and retain for future reference. Should the unit ever require maintenance, contact an authorized service location.

Use of controls, adjustments or the performance of procedures other than those specified may result in hazardous radiation exposure.

To prevent direct exposure to the laser beam, do not try to open the enclosure.

Location of the required label

(Sample shown below. Location of the label and manufacturing information may vary.)

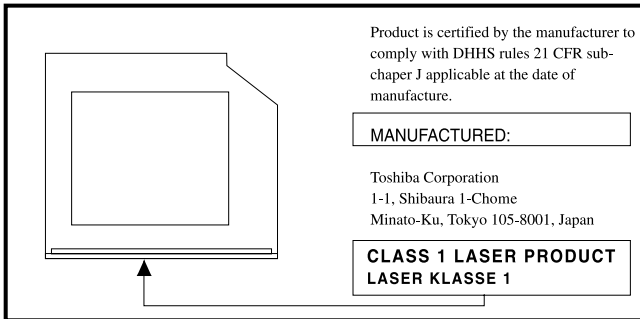

CAUTION: This appliance contains a laser system and is classified as a "CLASS 1 LASER PRODUCT." To use this model properly, read the instruction manual carefully and keep it for your future reference. In case of any trouble with this model, please contact your nearest "AUTHORIZED service station." To prevent direct exposure to the laser beam, do not try to open the enclosure.

CLASS 1 LASER PRODUCT
LASER KLASSE 1

Use of controls or adjustments or performance of procedures other than those specified in the owner's manual may result in hazardous radiation exposure.

Copyright

This guide is copyrighted by Toshiba America Information Systems, Inc. with all rights reserved. Under the copyright laws, this guide cannot be reproduced in any form without the prior written permission of Toshiba. No patent liability is assumed, however, with respect to the use of the information contained herein.

©2001 by Toshiba America Information Systems, Inc. All rights reserved.

Export Administration regulation

This document contains technical data that may be controlled under the U.S. Export Administration Regulations, and may be subject to the approval of the U.S. Department of Commerce prior to export. Any export, directly or indirectly, in contravention of the U.S. Export Administration Regulations is prohibited.

Notice

The information contained in this manual, including but not limited to any product specifications, is subject to change without notice.

TOSHIBA CORPORATION AND TOSHIBA AMERICA INFORMATION SYSTEMS, INC. (TOSHIBA) PROVIDES NO WARRANTY WITH REGARD TO THIS MANUAL OR ANY OTHER INFORMATION CONTAINED HEREIN AND HEREBY EXPRESSLY DISCLAIMS ANY IMPLIED WARRANTIES OF MERCHANTABILITY OR FITNESS FOR ANY PARTICULAR PURPOSE WITH REGARD TO ANY OF THE FOREGOING. TOSHIBA ASSUMES NO LIABILITY FOR ANY DAMAGES INCURRED DIRECTLY OR INDIRECTLY FROM ANY TECHNICAL OR TYPOGRAPHICAL ERRORS OR OMISSIONS CONTAINED HEREIN OR FOR DISCREPANCIES BETWEEN THE PRODUCT AND THE MANUAL. IN NO EVENT SHALL TOSHIBA BE LIABLE FOR ANY INCIDENTAL, CONSEQUENTIAL, SPECIAL, OR EXEMPLARY DAMAGES, WHETHER BASED ON TORT, CONTRACT OR OTHERWISE, ARISING OUT OF OR IN CONNECTION WITH THIS MANUAL OR ANY OTHER INFORMATION CONTAINED HEREIN OR THE USE THEREOF.

Trademarks

Satellite, Noteworthy, Fn-esse, and AccuPoint are registered trademarks, SecureSleep, SelectServ, FreedomWare, SmartMedia, Ask IRIS Online, and VirtualTech are trademarks, and InTouch is a service mark of Toshiba America Information Systems, Inc. and/or Toshiba Corporation.

Microsoft, Windows, Windows Media, DirectX, and DirectShow are registered trademarks of Microsoft Corporation.

Active Desktop is a trademark of Microsoft Corporation.

Intel and Pentium are registered trademarks and SpeedStep and Wake On LAN are trademarks of Intel Corporation.

LapLink is a registered trademark of Traveling Software, Inc.

WinDVD is a trademark of InterVideo, Inc.

CompuServe is a registered trademark of America Online, Inc.

RingCentral is a registered trademark of Ring Zero Systems, Inc.

i.LINK is a registered trademark of Sony Corporation.

SPANworks 2000 is a trademark of SPANworks, U.S.A.

Wi-Fi is a trademark of the Wireless Capability Ethernet Alliance.

Manufactured under license from Dolby Laboratories, Dolby, Dolby Digital Surround, and Dolby Digital are trademarks of Dolby Laboratories.

Easy CD Creator and Direct CD are trademarks of Adaptec, Inc.

Energy Star is a registered trademark of the U. S. Environmental Protection Agency.

All other brand and product names are trademarks or registered trademarks of their respective companies.

Energy Star compliance

As an Energy Star® partner, Toshiba has determined that this product is Energy Star Compliant.

Computer disposal information

This product contains mercury. Disposal of this material may be regulated due to environmental considerations. For disposal, reuse, or recycling information, please contact your local government or the Electronic Industries Alliance at www.eiae.org.

Contents

Introduction.....	23
This guide.....	23
Safety icons.....	24
Other icons used.....	25
Other documentation.....	25
Service options.....	26
Chapter 1: Finding Your Way Around.....	27
Making sure you have everything.....	27
Front with the display closed.....	28
Back.....	29
Right side.....	30
Left side.....	31
Front with the display open.....	32
Indicator panel.....	34
System indicator panel.....	34
CD or DVD control buttons.....	35
CD/DVD/Media Player power switch.....	36
Underside.....	38
Chapter 2: Getting Started.....	41

Selecting a place to work.....	41
Creating a computer-friendly environment.....	41
Keeping yourself comfortable.....	42
Precautions	45
Setting up your computer.....	46
Installing additional memory (optional).....	47
Removing a memory module.....	50
Connecting a mouse	50
Connecting a printer	50
Connecting the AC adapter	51
Charging the battery	53
Using the computer for the first time.....	54
Opening the display panel.....	54
Turning on the power	55
Using the AccuPoint II Pointing device	56
Setting up your software.....	57
Setting up a printer	58
Turning off the computer.....	61
Caring for your computer.....	62
Cleaning the computer.....	62
Moving the computer.....	63
Using a computer lock.....	63
Chapter 3: Learning the Basics.....	65
Computing tips.....	65
Using the keyboard.....	66
Character keys	67
Ctrl, Fn, and Alt keys.....	67
Function keys.....	67
Windows® special keys.....	68
Overlay keys.....	68
Starting a program.....	70
Saving your work.....	70
Printing your work.....	71
Using diskettes.....	71

Inserting and removing diskettes	72
Caring for diskettes	72
Backing up your files	73
Using your CD or DVD drive	74
Drive components and control buttons	74
Setting the CD/DVD/Media Player switch to CD/DVD ..	76
Setting the CD/DVD/Media Player switch to Media Player	77
Inserting a disc	77
Playing an audio CD	79
Creating a CD	80
Playing a DVD	81
Viewing the contents of a CD or DVD	81
Removing a disc with the computer on	81
Removing a disc with the computer off	82
Caring for CDs and DVDs	82
Setting up for communications	82
Using the modem	83
Connecting your computer to a network	83
Powering down the computer	84
Shut down command	84
Hibernation command	85
Standby command	85
Using Shut down	86
Shutting down more quickly	86
Starting again after Shut down	87
Using Hibernation	87
Starting again from Hibernation mode	87
Using Standby	88
Starting again from Standby	88
Chapter 4: Mobile Computing	89
Toshiba's energy-saver design	89
Running the computer on battery power	90
Using a second battery	90
Battery safety precautions	90

Maximizing battery life	91
Charging batteries	91
Charging the main and secondary batteries	92
Charging the RTC battery.....	92
Monitoring battery power.....	93
Determining remaining battery power.....	93
Conserving battery power.....	94
What to do when the battery runs low	95
Setting battery alarms	95
Changing the main battery	96
Removing the battery from the computer.....	96
Disposing of used batteries safely.....	97
Traveling tips.....	97

Chapter 5: Getting to Know the Windows Millennium

Edition Operating System.....	99
Lesson 1: Exploring the desktop	100
Finding your way around the desktop	100
Windows® Millennium Edition file system.....	103
Lesson 2: Using the AccuPoint II	103
Lesson 3: Learning about the Internet.....	106
Exploring the Web Tutorial.....	107
Lesson 4: Creating a new document.....	108
Lesson 5: Creating a new folder	109
Lesson 6: Starting programs.....	110
Lesson 7: Resizing, repositioning, and hiding windows.	112
Using the taskbar.....	113
Minimizing and maximizing windows	114
Resizing and moving windows	115
Lesson 8: Closing programs	116
Lesson 9: Creating shortcuts.....	116
Creating a shortcut to the Calculator.....	116
Creating a shortcut to the Character Map	117
Lesson 10: Changing the screen saver.....	120

Lesson 11: Setting the date and time	122
Lesson 12: Removing objects from the desktop	123
Lesson 13: Using System Restore	125
Lesson 14: If I am lost, what do I do?.....	126
Windows® Millennium Edition Help.....	126
Using the online tours and tutorials	128
Lesson 15: Turning off your computer.....	129
Chapter 6: Exploring Your Options.....	131
Windows® Millennium Edition special features	131
Personalizing your desktop	132
Customizing the taskbar.....	132
Bringing the world to your desktop.....	133
Changing desktop and browsing style.....	134
Personalizing individual windows	136
Adding a background to a window	137
Customizing window toolbars	137
Displaying a toolbar in a window.....	139
Displaying information about each folder.....	139
Connecting a monitor, keyboard and mouse.....	140
Using the programmable buttons	141
Using the Ethernet LAN Port	142
Accessing a LAN.....	143
Setting up a direct connection	143
Using a wireless connection	143
Setting up a dial-up connection.....	144
Exchanging data with another computer	144
Transferring files using a parallel port connection	144
Transferring files using the Infrared port.....	145
Connecting to the Internet.....	145
Making the physical connection	146
Signing up with an Internet Service Provider	147
Getting started.....	147
Using the Internet.....	148
The Internet.....	148

The World Wide Web	148
Surfing the Internet.....	149
Internet features.....	149
Uploading and downloading files from the Internet....	150
Toshiba's online resources.....	150
Conducting an electronic meeting	150
Sending a fax.....	151
Exploring video features	152
Viewing presentations or DVD movies on your television	152
Connecting a television to the S-video out port.....	152
Transferring and editing video data.....	155
Playing VideoCDs	155
Exploring audio features.....	156
Recording sounds	156
Using a microphone.....	157
Adjusting recording quality.....	158
Using external speakers or headphones	158
Using PC Cards.....	159
PC Card supporting software.....	159
Inserting PC Cards.....	160
Removing PC Cards.....	160
Hot swapping.....	161
Using SmartMedia cards.....	161
Inserting a SmartMedia card.....	161
Removing a SmartMedia card	162
Emulating a full-size keyboard	162
Chapter 7: WinDVD 2000.....	163
Playing DVDs.....	163
Using the WinDVD toolbar	165
Using the WinDVD status bar.....	165
Using the WinDVD control panel	166
Using the control panel playback buttons.....	167
Maximizing the video window.....	169

Using playlists.....	170
Creating playlists.....	170
Loading and playing playlists.....	172
Resuming normal playback after using playlists	172
Customizing WinDVD	172
Setting general properties	173
Setting audio properties.....	174
Setting display properties.....	176
Customizing the control panel.....	177
Using WinDVD Advanced Features	177
Zooming in	182
Panning.....	183
Zooming out.....	183
Adjusting the color balance.....	183
Launching an Internet browser from WinDVD.....	184
Getting Help	184
Exiting WinDVD.....	184
Chapter 8: If Something Goes Wrong	185
Problems that are easy to fix.....	185
Problems when you turn on the computer.....	187
The Windows® Millennium Edition operating system is not working.....	188
Using Startup options to fix problems.....	189
Internet problems.....	192
The Windows® Millennium Edition operating system can help you.....	193
Resolving a hardware conflict.....	194
A plan of action.....	194
Resolving hardware conflicts on your own.....	194
Fixing a problem with Device Manager.....	196
Memory card problems	198
Power and the batteries.....	198
Keyboard problems	200
AccuPoint II problems.....	201

Display problems.....	202
Disk drive problems	204
CD-ROM or DVD-ROM drive problems.....	206
Sound system problems	213
PC Card problems	214
Printer problems.....	217
Modem problems.....	218
Develop good computing habits	218
Using VirtualTech	220
If you need further assistance.....	221
Before you call.....	221
Contacting Toshiba.....	221
Other Toshiba Internet Web sites	222
Toshiba's worldwide offices.....	223
Appendix A: Hot Keys	227
Appendix B: Power Cable Connectors	229
Glossary	231
Index.....	245

Introduction

Welcome to the world of powerful and portable multimedia computers! With your new Toshiba notebook computer, your work can accompany you wherever you go.

Your Satellite Pro Series computer offers enhanced multimedia features and easy Internet access combined with great flexibility. Its Modular Bay enables you to switch between a diskette drive, CD-ROM, DVD-ROM, CD-ROM/RW, DVD-ROM/CD-RW drive, a second hard disk drive, or second battery as you need them. Your computer may also include the latest technology in wireless communications, enabling you to exchange information with as few or as many others as you want.

This guide

This guide introduces the computer's features. You can:

- ❖ Read the entire guide from beginning to end.
- ❖ Skim through and stop when a topic interests you.
- ❖ Use the table of contents and the index to find specific information.

If you are new to computers, or have not used a notebook computer before, read through the first couple of chapters to familiarize yourself with the components of the computer and how to turn it on. After that, seek out whatever interests you most.

Safety icons

This manual contains safety instructions that must be observed in order to avoid potential hazards that could result in personal injuries, damage to your equipment, or loss of data. These safety cautions have been classified according to the seriousness of the risk, and the icons highlight these instructions as follows:



***DANGER:** This icon indicates the existence of a hazard that could result in death or serious bodily injury if the safety instruction is not observed.*



***WARNING:** This icon indicates the existence of a hazard that could result in bodily injury if the safety instruction is not observed.*



***CAUTION:** This icon indicates the existence of a hazard that could result in damage to equipment or property if the safety instruction is not observed.*



***NOTE:** This icon indicates information that relates to the safe operation of the equipment or related items.*

Other icons used

Additional icons highlight other helpful or educational information:



TECHNICAL NOTE: This icon highlights technical information about the computer.



HINT: This icon denotes helpful hints and tips.



DEFINITION: This icon indicates the definition of a term used in the text.

Other documentation

In addition to this user's guide, your computer comes with the following documentation:

- ❖ An electronic version of the user's guide. Look for the user's guide icon on your desktop or install it from your Recovery and Configuration Builder CD provided with your computer.
- ❖ Guides for other programs that may come preinstalled on your computer and for additional programs on your Recovery and Configuration Builder CD.
- ❖ *Toshiba Accessories Information* lists accessories available from Toshiba and explains how to order them.
- ❖ The Microsoft® Windows® Millennium Edition operating system documentation which explains the features of the operating system.

Service options

Toshiba offers a full line of service options built around its SelectServ™ warranty programs. For more information, visit Toshiba's Web site at Toshiba.com.

If you have a problem or need to contact Toshiba, see [“If Something Goes Wrong”](#) on page 185.

Chapter 1

Finding Your Way Around

This chapter presents a “grand tour” of your notebook computer. It serves as a reference when you need to locate specific parts of the computer.

Making sure you have everything

Before doing anything else, consult the Quick Start card provided with your system to make sure you received everything. If any items are missing or damaged, notify your dealer immediately. For additional help, see [“If you need further assistance” on page 221](#).

Front with the display closed

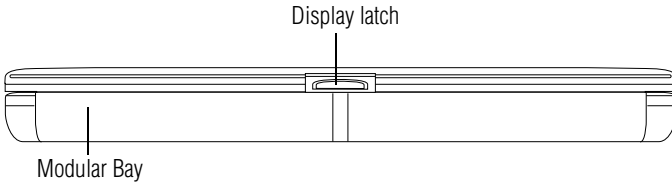

The display latch keeps the display panel closed and locked. To open the display panel, press the display latch and raise the panel.

The **Modular Bay** comes with a CD or DVD drive installed. This bay can accommodate a CD-ROM, CD-R, CD-RW, DVD-ROM, or multifunction DVD-ROM/CD-RW drive. It also supports a diskette drive, additional hard disk drive or secondary battery. The bay only supports one device at a time. It is designated as drive D:.



CAUTION: Never use a pencil to press the CD-ROM/DVD-ROM manual eject button. Pencil lead can break off inside the computer and damage it. Instead, use a slim object such as a straightened paper clip.

Back

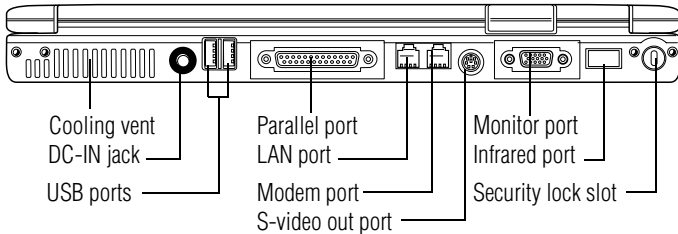

The **cooling vent** prevents the computer's central processing unit (CPU) from overheating so that it can continue to perform at its maximum speed.



CAUTION: To prevent possible overheating of the CPU, make sure you don't block the cooling vents.



The **DC-IN jack** is where you plug in the AC adapter.



The **USB (Universal Serial Bus) ports** allow you to connect USB peripherals to your computer.



DEFINITION: USB is a peripheral expansion standard that supports a data-transfer rate of up to 12 Mbps for peripherals such as keyboards, pointing devices, and monitors. USB peripherals have a single standard for cabling and connectors. The USB standard allows hot swapping of peripherals.



The **parallel port** lets you connect a parallel printer or other parallel device, including ECP-compatible devices.

The **LAN port** lets you connect the computer to a local area network using a 10/100 Ethernet link.



The **modem port** lets you use a modular cable to connect the modem directly to a standard telephone line. For more information, see [“Using the modem” on page 83](#).



The **S-video out port** allows you to connect a television or other video output device.



The **monitor port** allows you to connect an external monitor.



Infrared port—The fast infrared port allows cable-free communication with another device, such as a computer or printer, that has a compatible infrared port.



The **security lock slot** allows you to attach an optional PORT-Noteworthy[®] computer lock cable to your computer to secure it to a large, heavy object such as your desk.

Right side

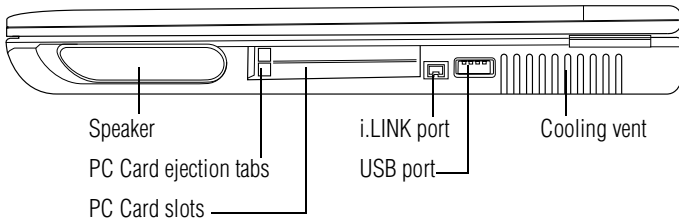

The two stacked **PC Card slots** support up to two Type I or Type II PC Cards, or one Type III PC Card. See [“Using PC Cards” on page 159](#) for more information.

The **PC Card ejection tabs** release PC Cards from the corresponding slots.

The **i.LINK® port** allows transfers of large quantities of data between the computer and an external device, such as a video camera.



The **USB (Universal Serial Bus) port** allows you to connect USB peripherals, such as a mouse, printer or external keyboard to your computer.

The **cooling vent** prevents the computer's central processing unit (CPU) from overheating so that it can continue to perform at its maximum speed.



CAUTION: To prevent possible overheating of the CPU, make sure you don't block the cooling vents.

Left side

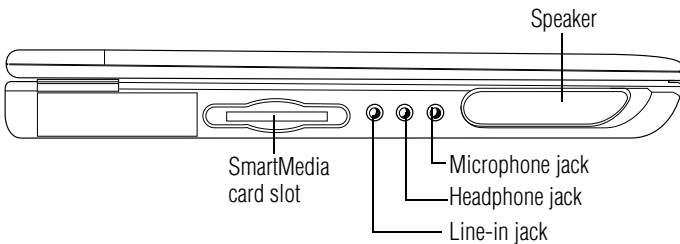

The **SmartMedia™ card slot** supports 2 MB, 4 MB, 8 MB, 16 MB, 32 MB and 64 MB. SmartMedia Random Access Memory (RAM) Cards. These small cards are about one-third the size of conventional PC Cards and are only 0.76mm in thickness. They are used in digital still cameras and various forms of portable information equipment. If Windows does not recognize an inserted SmartMedia card, try to remove and insert it again.



The 3.5 mm **headphone jack** lets you connect stereo headphones or other audio-output devices, such as external speakers. Connecting other devices automatically disables the internal speakers.



The 3.5 mm **microphone jack** lets you connect an external monaural microphone or other audio input device.

The **line-in jack** allows you to connect an external input device.

Front with the display open

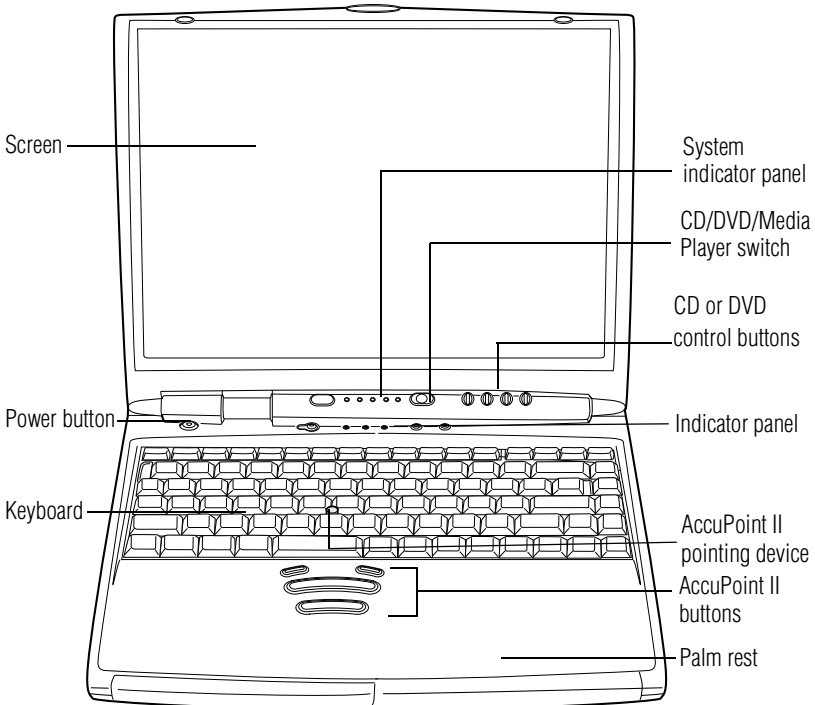

The **power button** turns the computer on and off.

The computer's **screen** is a liquid crystal display (LCD) that provides clear, sharp images. The **CD/DVD/Media Player switch**

sets the computer to turn on the CD/DVD player automatically if there is a disc in the DVD-ROM drive when the computer is turned off, or to power up and launch Windows Media® Player. For more information, see [“CD/DVD/Media Player power switch” on page 36](#).

The **CD or DVD control buttons** allow you to play audio CDs when the computer is turned off. You can also use them to play CDs and DVDs with the computer turned on. For a description of these controls, see [“CD or DVD control buttons” on page 35](#).

The lights on the **indicator panel** provide information about keyboard functions. For a description of these lights, see [“Indicator panel” on page 34](#).

The **AccuPoint II® pointing device** combines the function of a mouse with the convenience of never having to remove your hands from the keyboard.

The **AccuPoint II control buttons** work with the pointing device. The larger button acts as the primary button on a mouse. The smaller button acts as the secondary mouse button. The two small buttons above are the scroll buttons. For more information, see [“Using the AccuPoint II Pointing device” on page 56](#).

The **function keys**, when used with the Fn key, activate several different system functions. For more information, see [“Hot Keys” on page 227](#).

The 85-key **keyboard** provides all the functionality of a full-size keyboard. For more information, see [“Using the keyboard” on page 66](#).

The front panel provides a **palm rest** to assist you in maintaining proper posture while using the computer.

Indicator panel



The **caps lock light** glows when you press the Caps Lock key. When this light is on, pressing a letter key on the keyboard produces an uppercase (capital) letter.



The **cursor control mode light** glows when the cursor control overlay is on. When this light is on, pressing an overlay key moves the cursor in the direction of the white arrow printed on the key instead of typing the letter printed on the top of the key.



The **numeric mode light** glows when the numeric overlay is on. When this light is on, pressing an overlay key types the white number printed on the key instead of typing the letter printed on the top of the key.

System indicator panel

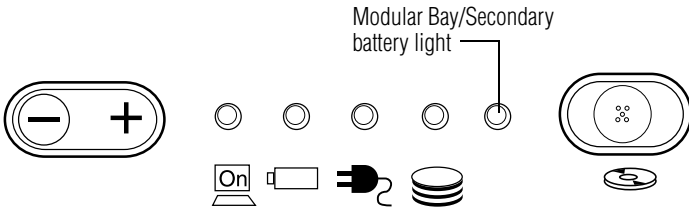

The **power on light** glows green when the computer is on. The light glows amber when the computer is in Standby mode.



The **main battery light** indicates the main battery's current charge. It glows green when the battery is fully charged. It glows amber while the battery is being charged. It does not glow if the external power source is disconnected or if the battery is completely discharged. For more information on determining remaining battery power, see [“Monitoring battery power” on page 93](#).



The **DC-IN light** glows green when the computer is connected to an external power source.



The **hard disk drive light** flashes green while the hard disk drive is being accessed.

The **Modular Bay/secondary battery light** flashes green when the Modular Bay is in use. This light is also the indicator for a secondary battery, if one is seated in the Modular Bay.



CAUTION: Never turn off the computer while any of the drives are in use. Doing so may damage the disk and result in loss of data.

CD or DVD control buttons

The control buttons on the top of the computer are for playing CDs and DVDs.

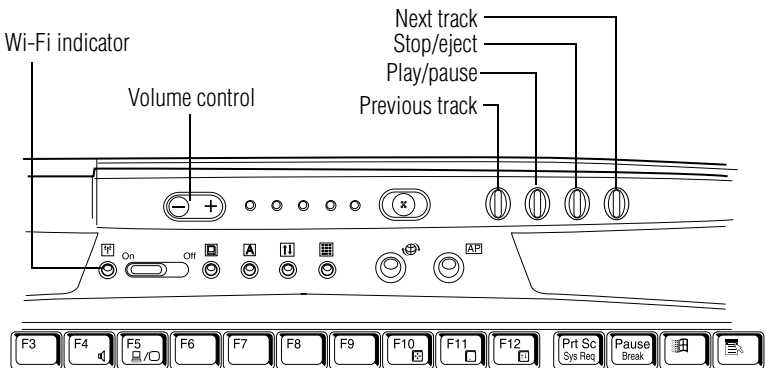

CD or DVD control buttons

The **volume control** allows you to set the volume level.

The **previous track button** returns to the preceding track on the disc.

The **play/pause button** starts playing the disc, or pauses the disc if it is currently playing.

The **stop/eject button** stops a disc that is currently playing. Press the button again to eject the disc.

The **next track button** skips to the following track on the disc.



Wi-Fi indicator light (for systems with Wi-Fi only)—The 802.11b (referred to as Wi-Fi™ — wireless fidelity) indicator light glows amber when the Wi-Fi is turned on. For more information on wireless networking, see [“Using the Ethernet LAN Port”](#) on page 142.

Wi-Fi on/off switch (for systems with Wi-Fi only)—The Wi-Fi on/off switch turns the optional wireless communication system on or off.



NOTE: For environments that do not permit wireless use or instruct you to turn off all radio devices (for example, aboard commercial aircraft), you should turn the Wi-Fi switch off.

CD/DVD/Media Player power switch

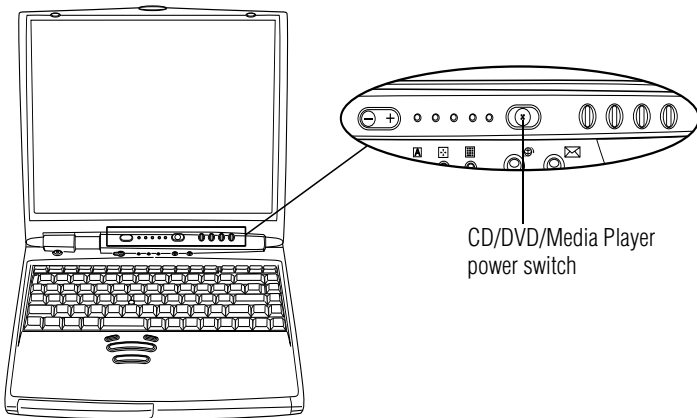

The CD/DVD/Media Player power switch allows you to play audio CDs with the computer turned off. This switch has two positions: CD/DVD, which is to the left as you face the computer from the front, and Media Player, which is to the right. What happens when you press this switch depends on what’s in the drive.

DVD playback and the power switch

With a DVD in the drive, setting the switch to the right turns on the computer and launches Windows Media® Player as the default. To play a DVD you will need to manually start WinDVD.

If there's a DVD in the drive, setting the switch to the left turns on the computer's main power and launches WinDVD™. When you open the display, WinDVD automatically starts playing the DVD title.

Audio CD playback and the power switch

With a CD in the drive, setting the switch to the right turns on both the computer's main power and launches Windows Media® Player. When you open the display, Windows Media® Player begins playing the CD.

If there's an audio CD in the drive, setting the switch to the left leaves the computer's main power off, but turns on the sound system and the disk activity light. To play the CD, press the Play button. To stop the CD, slide the switch to the left and hold it for two seconds.

What happens when the drive is empty

If there's nothing in the drive, setting the switch to the left turns on the sound system and the disk activity light.

With nothing in the drive, setting the switch to the right turns on the computer and launches Windows Media® Player. When you open the display, Windows Media® Player automatically plays the default audio file.

To open the CD/DVD tray, press either the eject button on the drive or the Stop button twice.

For more information about the CD or DVD controls, see [“Using your CD or DVD drive” on page 74](#).

With nothing in the drive, setting the switch to the right turns on both the computer's main power and the power to the sound system. When you open the display, Windows Media[®] Player launches, and the sound system plays the default audio file.

For more information, see [“Using your CD or DVD drive”](#) on page 74.

Underside

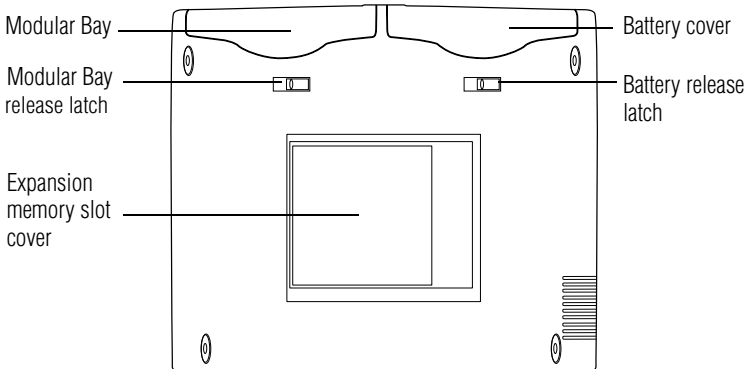

The **Modular Bay** allows you to add a CD-ROM, DVD-ROM, CD-R, or DVD-ROM/CD-RW multifunction drive. You can also add a diskette drive, secondary battery, or an additional hard drive.

The **Modular Bay release latch** allows you to remove modules.

The **expansion memory slot cover** protects the two expansion memory slots where you insert additional memory. See [“Installing additional memory \(optional\)”](#) on page 47 for detailed information.



The **battery cover** protects the battery. For information about replacing the battery, see [“Changing the main battery”](#) on page 96.

- 🔒 The **battery release latch** secures the battery cover to the computer, preventing the cover from dislodging from the computer case.

— Blank Page —

Chapter 2

Getting Started

This chapter provides tips for working comfortably, describes how to connect components, and explains what to do the first time you use your notebook computer.

Selecting a place to work

Your computer is portable and designed to be used in a variety of circumstances and locations.

Creating a computer-friendly environment

Place the computer on a flat surface which is large enough for the computer and any other items you need to use, such as a printer. Leave enough space around the computer and other equipment to provide adequate ventilation and prevent overheating.

To keep your computer in prime operating condition, protect your work area from:

- ❖ Dust, moisture, and direct sunlight.

- ❖ Equipment that generates a strong electromagnetic field, such as stereo speakers (other than speakers that are connected to the computer) or speakerphones.
 - ❖ Rapid changes in temperature or humidity and sources of temperature change such as air conditioner vents or heaters.
 - ❖ Extreme heat, cold, or humidity.
 - ❖ Liquids and corrosive chemicals.
-



CAUTION: If you spill liquid into the computer, turn it off, unplug it from the AC power source, and let it dry out completely before turning it on again.

If the computer does not operate correctly after you turn it back on, contact a Toshiba authorized service provider.

Keeping yourself comfortable

Strain and stress injuries are becoming more common as people spend more time using their computers. With a little care and proper use of the equipment, you can work comfortably throughout the day.

This section provides hints on avoiding strain and stress injuries. For more information, consult books on ergonomics, repetitive-strain injury, and repetitive-stress syndrome.

Placement of the computer

Proper placement of the computer and external devices is important to avoid stress-related injuries.

- ❖ Place the computer on a flat surface at a comfortable height and distance. You should be able to type without twisting your torso or neck, and look at the screen without slouching.
- ❖ If you are using an external monitor, the top of the display should be no higher than eye level.

- ❖ If you use a paper holder, set it at about the same height and distance as the screen.

Seating and posture

When using your computer, maintain good posture with your body relaxed and your weight distributed evenly. Proper seating is a primary factor in reducing work strain. Some people find a backless chair more comfortable than a conventional chair.

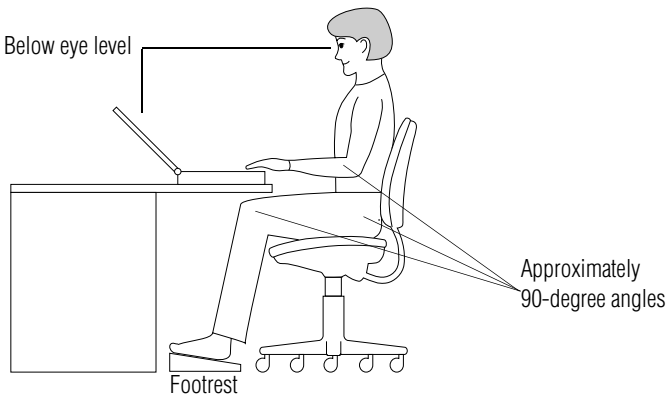

Correct posture and positioning of the computer

Whichever type you choose, use the following guidelines to adjust your chair for maximum computing comfort.

- ❖ Position your chair so that the keyboard is at or slightly below the level of your elbow. You should be able to type comfortably with your shoulders relaxed and your forearms parallel to the floor.

If you are using a conventional chair:

- ❖ Your knees should be slightly higher than your hips. If necessary, use a footrest to raise the level of your knees and ease the pressure on the back of your thighs.
- ❖ Adjust the back of your chair so that it supports the lower curve of your spine. If necessary, use a cushion to provide

extra back support. Lower-back-support cushions are available at many office supply stores.

- ❖ Sit with your back straight so that your knees, hips, and elbows form approximately 90-degree angles when you work. Do not slump forward or lean back too far.

Lighting

Proper lighting can improve the visibility of the display and reduce eyestrain.

- ❖ Position the display panel or external monitor so that sunlight or bright indoor lighting does not reflect off the screen. Use tinted windows or shades to reduce glare.
- ❖ Avoid placing your computer in front of a bright light that could shine directly in your eyes.
- ❖ If possible, use soft, indirect lighting in your computer work area.

Arms and wrists

- ❖ Avoid bending, arching, or twisting your wrists. Keep them in a relaxed, neutral position while typing.
- ❖ Exercise your hands, wrists, and arms to improve circulation.



***WARNING:** Using the computer keyboard incorrectly may result in discomfort and possible injury. If your hands, wrists, and/or arms bother you while typing, stop using the computer and rest. If the discomfort persists, consult a physician.*

Work habits

The key to avoiding discomfort or injury from strain is to vary your activities. If possible, schedule a variety of tasks into your

working day. Finding ways to break up the routine can reduce stress and improve your efficiency.

- ❖ Take frequent breaks to change position, stretch your muscles, and relieve your eyes. A break of two or three minutes every half hour is more effective than a long break after several hours.
- ❖ Avoid performing repetitive activities for long periods. Intersperse such activities with other tasks.
- ❖ Focusing your eyes on your computer screen for long periods can cause eyestrain. Look away from the computer frequently and focus your eyes on a distant object for at least 30 seconds.

Precautions

Your notebook computer is designed to provide optimum safety and ease of use, and to withstand the rigors of travel. You should observe certain precautions to further reduce the risk of personal injury or damage to the computer.

- ❖ Avoid prolonged physical contact with the underside of the computer.

If the computer is used for long periods, its case can become very warm. While the temperature may not feel too hot to the touch, if you maintain physical contact with the computer for a long time (if you rest the computer on your lap, for example), your skin might suffer low-heat injury.

- ❖ Never apply heavy pressure to the computer or subject it to sharp impacts. Excessive pressure or impact can damage computer components or otherwise cause your computer to malfunction.
- ❖ Some PC Cards can become hot with prolonged use. If two cards are installed, both can become hot even if only one is being used. Overheating of a PC Card can result in errors or instability in its operation.

Be careful when you remove a PC Card that has been used for a long period.

- ❖ Avoid spilling liquids into the computer's keyboard.

If you do spill a liquid that gets into the keyboard, turn off the computer immediately. Leave the computer turned off overnight to let it dry out before you use it again.

- ❖ Never turn off the computer if a drive light indicates a drive is active.

Turning off the computer while it is reading from or writing to a disk may damage the disk, the drive, or both.

- ❖ Keep the computer and disks away from objects that generate strong magnetic fields, such as large stereo speakers.

Information on disks is stored magnetically. Placing a magnet too close to a disk can erase important files.

- ❖ Scan all new files for viruses.

This precaution is especially important for files you receive via diskette, email, or download from the Internet.

Occasionally, even new programs you buy from a supplier may contain a computer virus. You'll need a special program to check for viruses. Ask your dealer to help you.

Setting up your computer

Your computer contains a rechargeable high-capacity battery that needs to be charged before you can use it.

To use external power or to charge the battery, you must attach the AC adapter. See [“Connecting the AC adapter” on page 51](#).

To register your computer online, or to sign up for an Internet account, you must connect the built-in modem to a telephone line. See [“Using the modem” on page 83](#).

Before starting to use your computer, you may also want to:

- ❖ Add more memory
- ❖ Connect a mouse
- ❖ Connect a full-size keyboard (see “Connecting a monitor, keyboard and mouse” on page 140)
- ❖ Connect an external monitor (see “Connecting a monitor, keyboard and mouse” on page 140)
- ❖ Connect a local printer
- ❖ Install PC Cards (see “Using PC Cards” on page 159)

Installing additional memory (optional)

Your computer comes with enough memory to run most of today’s popular applications. You may want to increase the computer’s memory if you use complex software or process large amounts of data.

Additional memory comes in 64 MB, 128 MB, and 256 MB modules. You can only install two modules in your computer’s expansion memory slots, located on the bottom of your computer.

You need a standard Phillips no. 1 screwdriver to install a memory module.



CAUTION: To avoid damaging the computer's screws, use a standard Phillips no. 1 screwdriver that is in good condition.

If you are adding memory after you have started to use the computer, begin at step 1, otherwise skip to step 2.

- 1** If the computer is on, click **Start, Shut Down**, select **Shut down**, then click **OK**.

The operating system turns off the computer.

- 2 Unplug and remove any cables connected to the computer.
- 3 Close the display panel and turn the computer upside down to locate the expansion memory slot cover.

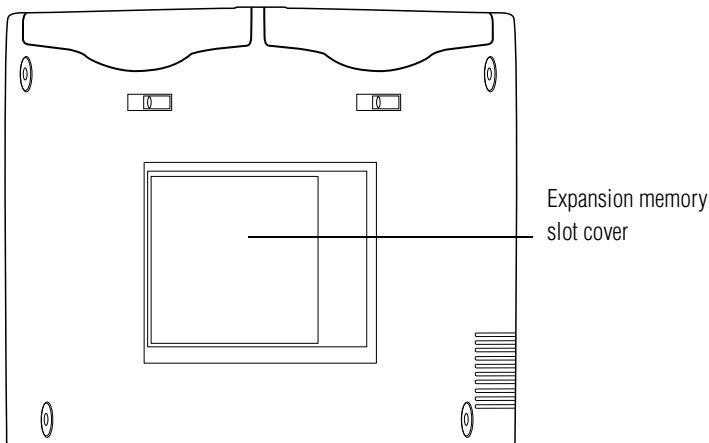

Base of a Satellite Pro 3000/3005 Series computer

- 4 Using the standard Phillips no. 1 screwdriver, unscrew the two screws that secure the expansion memory slot cover, then remove the memory slot cover.
- 5 Put the screws and the cover in a safe place so that you can retrieve them later.



CAUTION: Static electricity can damage the memory module. Before you handle the module, touch a grounded metal surface to discharge any static electricity you may have built up.

To avoid damaging the memory module, be careful not to touch its gold connector bar (on the side you insert into the computer).

- 6 Remove the memory module from its antistatic packaging.

- 7 Holding the memory module by its edges so that the gold connector bar faces the slot, fit the module into the socket.
- 8 Gently press down on the memory module connector until the clips snap into place.

Do not force the module into position. The memory module should be level when secured in place.

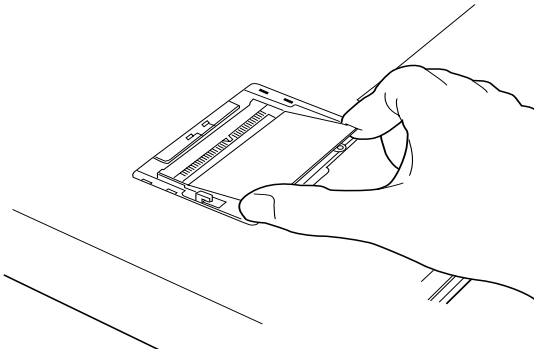

Inserting the memory module



CAUTION: Avoid touching the connectors on the memory module or on the computer. Grease or dust on the connectors may cause memory access problems.

- 9 Replace the expansion memory slot cover.
- 10 Replace the screws and tighten them.
- 11 Turn the computer over and reconnect any cables you removed.

When you turn on your computer, it automatically recognizes the additional memory. If the computer does not recognize the memory, shut down the computer, remove the memory slot cover, and make sure the memory module is seated properly, as described in step 8.

Removing a memory module

- 1 Follow steps 1 through 5 in “[Installing additional memory \(optional\)](#)” on page 47.
- 2 Gently pull up on the module to disconnect it, then gently pull it out of the slot.
- 3 Complete the procedure by following steps 9 through 11.

Connecting a mouse

You may want to use a mouse instead of the computer’s built-in pointing device.

To connect a USB mouse, plug the mouse cable into one of the USB ports.

Connecting a printer



CAUTION: Connecting the printer cable while the computer is on may damage the printer, the computer, or both.

Before connecting a printer, you need to know whether it uses a serial or a parallel interface. Check the printer’s documentation. If the printer can be switched between serial and parallel mode, choose parallel because it is faster.

You also need a suitable printer cable, which may come with your printer. Otherwise, you can purchase one from a computer or electronics store.



NOTE: If your printer is ECP- or IEEE-compliant, make sure your printer cable is an IEEE 1284 cable.

To connect a parallel printer:



- 1 Connect the printer cable to the printer and to the computer's parallel port.

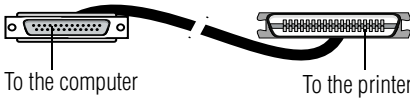

Identifying the ends of a parallel printer cable

- 2 Plug the printer's power cable into a live AC outlet.

See your printer documentation for additional configuration steps, or see “Setting up a printer” on page 58.

Connecting the AC adapter

The AC adapter enables you to power the computer from an AC outlet and to charge the computer's batteries. The AC power light on the computer glows when the device is plugged in.

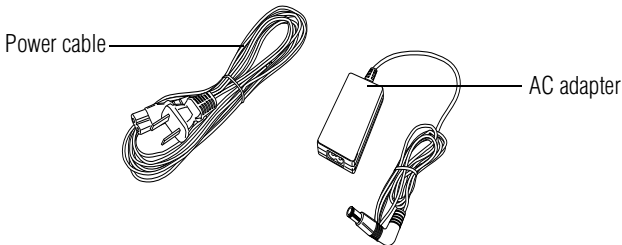

Power cable and AC adapter



DANGER: Damaged power cables can cause fire or electric shock. Never modify, forcibly bend, place heavy objects on top of, or apply heat to the power cable.

If the power cable becomes damaged or the plug overheats, discontinue use. There is a risk of electric shock.

Never remove the power plug from the outlet with wet hands. Doing so may cause an electric shock.

To connect AC power to the computer:

- 1** Connect the power cable to the AC adapter.

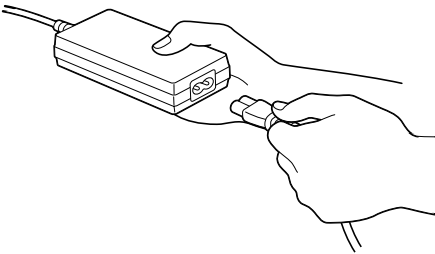

Connecting the power cable to the AC adapter



- 2** Plug the AC adapter into the DC-IN jack on the back of the computer.

To locate the DC-IN jack, see [“Back” on page 29](#).

- 3 Connect the power cable to a live electrical outlet.

The AC power and battery lights glow.



CAUTION: Using the wrong AC adapter could damage your computer. Toshiba assumes no liability for any damage in such cases. The current rating for the computer is 3.16 amperes.

Never pull directly on the power cable to unplug it. Hold the power plug when removing the cable from the outlet.

Charging the battery

Before you can use the battery to power the computer, you must charge it. Connect the computer to a live power outlet using the AC adapter and power cable. The on/off light glows green and the battery light glows amber to show that it is charging.

Once the computer is connected to a power outlet, you can charge the battery with the computer turned off or on. It takes several hours to charge the battery when the computer is off. It takes much longer to charge the battery when the computer is on. If the computer is not consuming full power, the time required to charge the battery is reduced.

For more information on battery use, see [“Running the computer on battery power”](#) on page 90.



CAUTION: Once the battery is charged for the first time, avoid leaving the computer plugged in and turned off for more than a few hours at a time. Continuing to charge a fully charged battery can damage the battery.



NOTE: Battery life and charge time may vary depending on the applications, power management settings, and features used.

Using the computer for the first time

Opening the display panel

Press the display latch and lift the display panel.

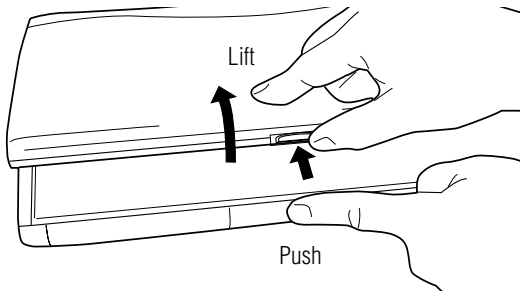

Opening the display panel



CAUTION: To avoid damaging the display panel, don't force it beyond the point where it moves easily.

Never lift or move the computer using the display panel.

Turning on the power

- 1 Check that all the drives are empty.
- 2 If you have a printer connected to your computer, turn on the printer and wait until the printer indicates that it is ready (on line).
- 3 Turn on the computer by pressing and releasing the power button located on the top of the keyboard. For an illustration to help you locate this button, see “[Front with the display open](#)” on page 32.



NOTE: When you turn on the computer for the first time, don't turn off the power again until the operating system has loaded completely.



The AC power light glows when the computer is connected to an external power source.



The battery light:

- ❖ Glows amber while the battery is being charged.
- ❖ Glows green when the battery is fully charged.
- ❖ Is unlit when the computer is not connected to an external power source. For information on determining battery power, see “[Monitoring battery power](#)” on page 93.



The hard disk drive light flashes to indicate that the hard disk drive is currently in use.

The Modular Bay indicator light flashes when the Modular Bay is in use.



CAUTION: Never turn off the computer while any of the drives are in use.

Using the AccuPoint II Pointing device

The round button in the middle of the keyboard is the AccuPoint II pointing device. It enables you to move the cursor and to select items on the screen. (If you would rather use a mouse or trackball, you can connect one to one of the computer's USB ports. See [“Connecting a mouse” on page 50](#) for more information.)

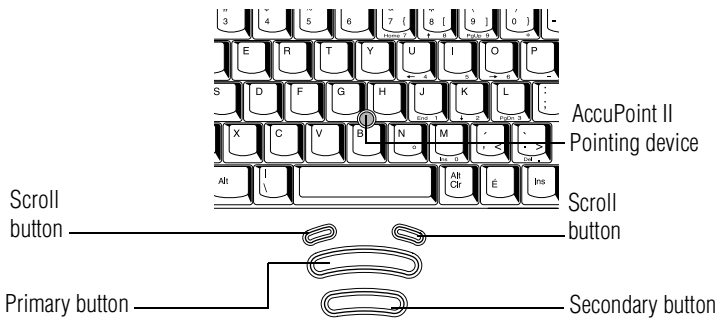

AccuPoint II control buttons and pointing device

To move the cursor, gently push the pointing device in the direction you want the cursor to move. Pushing harder on the pointing device moves the cursor faster.

Control buttons

When a step instructs you to click or choose an item, move the cursor to the item, then press and release the primary button. To double-click, press the primary button twice in rapid succession. The primary button usually corresponds to the left mouse button.

The function of the secondary button depends on the program you are using. It usually corresponds to the right mouse button. Check your program's documentation to find whether it uses the right mouse button.

Scroll buttons

You can scroll up and down a document by using the two scroll buttons. The one on the left scrolls up and the one on the right scrolls down.

Setting up your software

The first time you turn on your computer, the operating system guides you through several essential steps to set up your software. These steps may or may not appear in the following order:

- ❖ Select your time zone.

Select one of the time zones listed by clicking the up and down arrow keys to highlight the appropriate time zone, then click **Next** to change the setting.

- ❖ Confirm acceptance of Microsoft's End User License Agreement and complete information about the operating system.



- ❖ You may be offered the opportunity to register the purchase of your computer with Toshiba. If not, make sure you register later by double-clicking the Registration icon on your desktop.



NOTE: To register online, your computer's modem must be connected to a voice-grade telephone line, or to a Local Area Network.

To register your computer at a later time, select **No, I do not want to register at this time**.

- ❖ Read about Warranty Extensions and Upgrades.

This step provides important information from Microsoft.

- ❖ Sign up for Internet access.

This step guides you through signing up for a new Internet account, or assists you in setting up your computer to work with your existing Internet account.

Completing installation

Upon completion, you will be prompted to click **Finish** to restart your computer.

Setting up a printer

If you started your computer with a printer connected and turned on, it may have been detected automatically (Plug and Play). If this is not the case, then you must install the printer driver for the model of printer that is connected to your computer. You install the printer driver either by following the instructions indicated in your printer manual, or by using the Windows[®] Millennium Edition operating system Add Printer Wizard.

If you plan to set up a printer later, click **Cancel**.

Using the Add Printer Wizard

To set up a printer with the Add Printer Wizard:

- 1 Click the **Start** button, then point to **Settings**, and click **Printers**.

The Printers window appears.

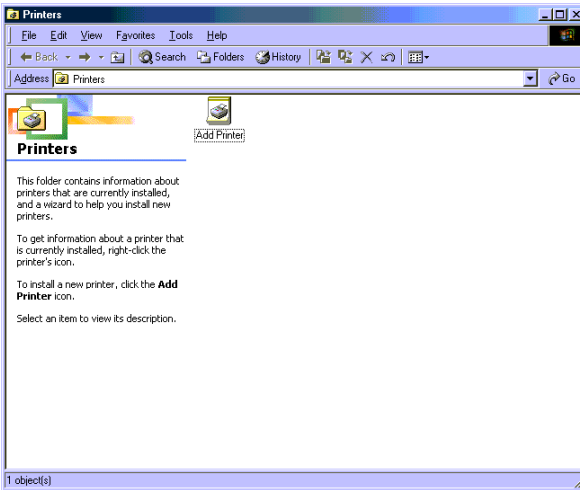

Sample Printers window

- 2 Double-click **Add Printer**.

The Add Printer Wizard starts.



Sample Add Printer Wizard

3 Click **Next**.

The Add Printer Wizard asks you to select your printer.



TECHNICAL NOTE: If your printer is Plug and Play, the Windows® Millennium Edition operating system recognizes it automatically. You can ignore the remainder of this section. See your printer manual.

4 If the printer you are setting up:

- ❖ Is not connected to a network, select **Local printer**.
- ❖ Is connected to a network, select **Network printer**.

5 Click **Next**.

The Add Printer Wizard prompts you to select your printer.

6 From the list of manufacturers and printers, select your printer, then click **Next**.

7 Select the port settings according to the instructions in your printer's documentation and the port to which your printer is connected, then click **Next**.

The Add Printer Wizard prompts you to enter a “friendly” printer name.

- 8 Enter a name for your printer.



HINT: If you are using more than one printer, make sure the name is descriptive enough to help you tell the difference.

- 9 To set up the printer to be:
 - ❖ The default printer for the Windows[®] Millennium Edition operating system, click **Yes**.
 - ❖ Available when specifically requested, click **No**.

- 10 Click **Next**.

The operating system prompts you to print a test page.

- 11 If your printer is connected and turned on, click **Finish** to print a test page.

To complete the setup procedure without printing a test page, click **No**, then click **Finish**.

You are now ready to print.

- 12 If you requested a test page, click **OK** to print.

Depending on your program, you may see various messages indicating the status of your print job.

Turning off the computer

It is a good idea to turn off your computer when you are not using it for a while.

If you are using the computer for the first time, leave the computer plugged into a power source (even though the computer is off) to fully charge the main battery. With the computer off, it may take up to three hours to recharge the main battery.

Guidelines for turning off the computer:

- ❖ If you have work in progress and are not connected to a network, you can use the Windows Standby command to save your system settings to memory so that, when you turn on the computer again, you automatically return to where you left off.
- ❖ To leave the computer off for a longer period, you can use the Windows Shut Down command instead. Alternatively, use Hibernation mode to save the system settings to the hard disk.
- ❖ Never turn off the power while a disk light on the system indicator panel is on. Doing so may damage your hard disk, diskette drive, or DVD-ROM drive.

For more information, see [“Powering down the computer”](#) on page 84.

Caring for your computer

This section gives tips on cleaning and moving your computer, and explains how to fit an antitheft lock. For information about taking care of your computer’s battery, see [“Running the computer on battery power”](#) on page 90.

Cleaning the computer

To keep your computer clean, gently wipe the display panel and exterior case with a lightly dampened cloth. Ask your Toshiba dealer for suggestions for appropriate cleaning products.



CAUTION: Keep liquid, including cleaning fluid, out of the computer’s keyboard, speaker grille, and other openings. Never spray cleaner directly onto the computer. Never use harsh or caustic chemical products to clean the computer.

Moving the computer

Before moving your computer, even across the room, make sure all disk activity has ended (the disk activity lights stop glowing) and all external peripheral cables are disconnected.



CAUTION: Never pick up the computer by its display panel or by the back (where the ports are located).

Although your notebook computer is built to withstand reasonable shock and vibration, transport it in a carrying case for long trips. You can purchase a carrying case from your Toshiba dealer or visit Toshiba's Web site at toshibaaccessories.com.

Using a computer lock

You may want to secure your computer to a heavy object such as your desk. The easiest way to do this is to purchase an optional PORT-Noteworthy computer lock cable.

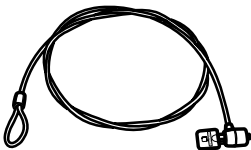

PORT-Noteworthy computer lock cable

To secure the computer:

- 1** Loop the cable through or around some part of a heavy object. Make sure there is no way for a potential thief to slip the cable off the object.
- 2** Pass the locking end through the loop.

-  **3** Insert the cable's locking end into the security lock slot located on the left side of the computer, then rotate the key a quarter turn and remove it.

The computer is now securely locked to deter computer theft.

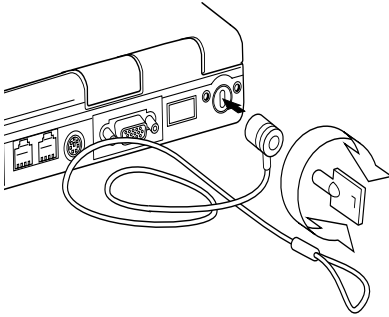

Locking the computer

Chapter 3

Learning the Basics

This chapter lists some computing tips and provides important information about basic features.

Computing tips

- ❖ Save your work frequently.

Your work stays in the computer's temporary memory until you save it to the disk. You will lose all unsaved work, if, for example, a system error occurs and you must restart your computer, or your battery runs out of charge while you are working. Your computer can be configured to warn you when the battery is running low. See [“Setting battery alarms” on page 95](#).



HINT: Some programs have an automatic save feature which you can turn on. This feature saves your file to the hard disk at preset intervals. See your software documentation for details.

- ❖ Back up your files to diskettes (or other removable storage media) on a regular basis. Label the backup copies clearly and store them in a safe place.

If your hard disk suddenly fails, you may lose all the data on it unless you have a separate backup copy.

- ❖ Use ScanDisk, Disk Defragmenter, and the Maintenance Wizard regularly to conserve disk space and help your computer perform at its optimal level. Consult your Windows® Millennium Edition operating system documentation for more information on these and other utilities.
- ❖ Before turning off the computer, always use the Shut down command (unless you want to use Standby or Hibernation mode as described in [“Powering down the computer”](#) on page 84).



CAUTION: The operating system records information, such as your desktop setup, during its shutdown procedure. If you don't let the operating system shut down normally, details such as new icon positions may be lost.

Using the keyboard

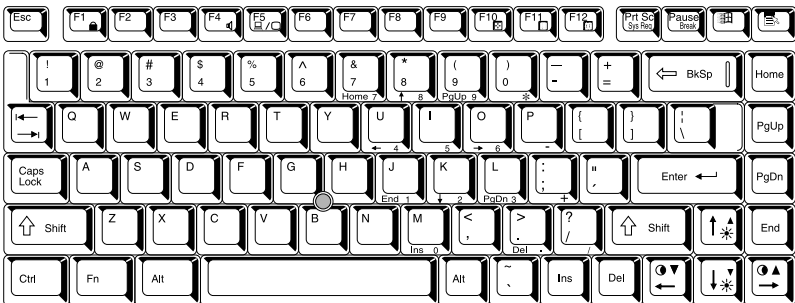

Keyboard

Character keys

Typing with the character keys is very much like typing on a typewriter, except that:

- ❖ The spacebar creates a space character instead of just passing over an area of the page.
- ❖ The lowercase l (el) and the number 1 are not interchangeable.
- ❖ The uppercase letter O and the number 0 are not interchangeable.
- ❖ The Caps Lock key changes only the alphabet keys to upper case — the number and symbol keys are not affected. The caps lock light on the keyboard indicator panel illuminates when you press the Caps Lock key.



Ctrl, Fn, and Alt keys



Ctrl, Fn and Alt keys

The Ctrl, Fn, and Alt keys do different things depending on the program you are using. For more information, see your program documentation.

Function keys

The function keys (not to be confused with the Fn key) are the 12 keys at the top of the keyboard.



Function keys

F1 through F12 are called function keys because they run programmed functions when you press them. Used in

combination with the Fn key, function keys marked with icons run specific functions on the computer.

Windows® special keys

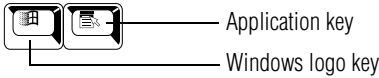

Windows® special keys

The keyboard provides two keys that have special functions in the Windows® operating system:

- ❖ The Windows® logo key opens the Start menu.
- ❖ The Application key has the same function as the secondary AccuPoint II control button (or right mouse button).

Overlay keys

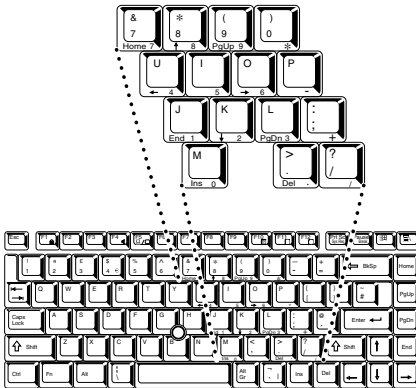

Keyboard overlay keys

The keys with gray numbers and symbols on the front of them form the numeric and cursor overlay. This overlay lets you enter numeric data or control the cursor as you would using the ten-key keypad on a desktop computer's keyboard.

Using the numeric keypad overlay



To turn on the numeric keypad overlay, press Fn and F11 simultaneously. The numeric mode light on the keyboard indicator panel glows when the numeric overlay is on.

You can still use the overlay keys to type alphabetic characters while the numeric overlay is on. To do so:

- ❖ For lowercase letters, hold down Fn while you type the letters.
- ❖ For uppercase letters, hold down both Fn and Shift while you type the letters.

To use the cursor control overlay when the numeric overlay is on, press and hold down Shift while you use the cursor control keys. To return to the numeric overlay, release Shift.

To turn off the numeric keypad overlay, hold down the Fn key and press F11 again. The numeric mode light on the keyboard indicator panel goes out.

Using the cursor control overlay



To turn on the cursor control overlay, press Fn and F10 simultaneously. The cursor control mode light on the keyboard indicator panel glows when the cursor control overlay is on.

To type alphabetic characters while the overlay is on:

- ❖ For lowercase letters, hold down Fn while you type the letters.
- ❖ For uppercase letters, hold down both Fn and Shift while you type the letters.

To use the numeric keypad overlay when the cursor control overlay is on, hold down Shift while you use the numeric overlay keys. To return to the cursor control overlay, release Shift.

To turn off the cursor control overlay, hold down the Fn key and press F10 again. The cursor control mode light on the keyboard indicator panel goes out.

Starting a program

The easiest way to start a program is to click the name of the file that contains the information you want to work on. To find the file, use My Computer or Windows Explorer.

If you prefer to open the program first, you have four options:

- ❖ Double-click the icon for the program on your desktop
- ❖ Use the Start menu
- ❖ Use Windows Explorer or My Computer to locate the program file
- ❖ Use the Run dialog box

The Windows[®] Millennium Edition operating system tutorial chapter gives step-by-step instructions for starting a program from the Start menu. See [“Lesson 6: Starting programs”](#) on page 110.

Saving your work

Before you turn off the computer, save your work to the hard disk drive or a diskette.



NOTE: Always save your data even when you are using the Standby command. If your battery fully discharges, your information will be lost. Your computer can be configured to warn you when the battery is running low, see [“Setting battery alarms”](#) on page 95.

Many programs offer a feature that saves documents at regular intervals, such as every 15 minutes. Check your programs’ documentation to see whether they have an automatic save feature.

To save:

- ❖ A file you are updating, open the program’s **File** menu and click **Save**.

- ❖ A new file, choose **Save As** from the **File** menu, type a name for the file, and click **OK**.



*HINT: To make another copy of the file you are currently working with, choose **Save As** from the **File** menu and give the new file a different name.*

For information on how to name a file, see “[Windows® Millennium Edition file system](#)” on page 103.

Printing your work

Verify that the Windows® Millennium Edition operating system is set up for your printer as described in “[Setting up a printer](#)” on page 58.



TECHNICAL NOTE: You only need to set up the printer the first time you connect it. If you use more than one printer or are changing printers, you will need to set up the operating system to run with the additional printer(s).

To print a file:

- 1 If your printer is not on, turn it on now.
- 2 In the **File** menu of your program, click **Print**.
The program displays a Print dialog box.
- 3 Click **OK** to print.

Using diskettes

The 3.5-inch diskette drive, which fits in the Modular Bay, lets you use either double-density (720 KB) or high-density (1.44 MB) diskettes for data transfer and storage.

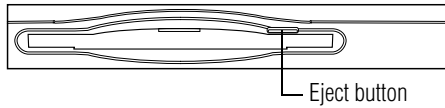

Diskette drive

The Modular Bay/Secondary battery light glows when the diskette drive is in use.

Inserting and removing diskettes

- 1 Hold the diskette so that the arrow on its upper surface points toward the drive.
- 2 Push the diskette gently into the drive slot on the left side of the computer. When the diskette is in place, the eject button pops out.

To release a diskette from the drive, push the eject button.



CAUTION: Never press the eject button or turn off the computer while the light is glowing. Doing so could destroy data and damage the diskette or the drive.

Caring for diskettes

- ❖ Store your diskettes properly to protect them and keep them clean.
- ❖ If a diskette is dirty, clean it with a soft cloth moistened in water. Do *not* use cleaning fluids.
- ❖ Never slide back the protective metal cover.
- ❖ Never touch the magnetic surface of a diskette. Fingerprints can prevent the drive from reading the data stored on a diskette.
- ❖ Never twist or bend a diskette.

- ❖ Keep diskettes at room temperature and avoid exposing them to direct sunlight. Otherwise data may be lost.
- ❖ Never place heavy objects on your diskettes.
- ❖ Never eat, smoke, or use erasers near your diskettes. Foreign particles can damage the diskette's surface.
- ❖ Keep your diskettes away from sources of magnetism, such as speakers and radios, since these can destroy data.

Backing up your files

Backing up your files means copying individual files to a diskette or copying entire sections of your hard disk to another device, such as a tape drive.

- 1 Insert a diskette into the diskette drive.
- 2 Double-click the **My Computer** icon on the Windows[®] desktop.
- 3 Double-click the drive that contains the file you want to copy.
- 4 Double-click the folder that contains the file, then click the file you want to copy.



HINT: You can use the Ctrl or Shift keys to select more than one file.

- 5 Click **File**, then click **Send To**.
- 6 Click the icon for the diskette drive (3 1/2 floppy [D:]).



HINT: You can also back up a file to a diskette by clicking the file (or files) you want to backup with the secondary button, then pointing to Send To and clicking 3 1/2 Floppy (D:).

Using your CD or DVD drive

Your computer may have a CD-ROM drive, CD-R drive, CD-RW drive, DVD-ROM drive, or a DVD-ROM/CD-RW multifunction drive. CD-ROM drives can play back prerecorded CDs. DVD-ROM drives can play back both prerecorded CDs and DVDs. With a CD-RW drive you can write files (including music) to a CD-Recordable (CD-R) or CD-Rewritable (CD-RW) disc. A DVD-ROM/CD-RW multifunction drive can do all of these things.

Compact discs (CDs) store up to 600 MB of data or music. You use CD-ROMs to load and run software, and to access reference material such as catalogs, as well as listen to music.

A special feature allows you to play audio CDs even when the computer is turned off. For more information, see “[CD/DVD control buttons](#)” on page 76.

Digital versatile discs (DVDs) provide a significant increase in data storage and support features that are not available on any other video platform. These features include wide-screen movies, multiple language tracks, digital surround sound, multiple camera angles, and interactive menus. The computer can play high-resolution video at up to 30 frames per second.



NOTE: For optimum DVD performance, it is recommended that you play DVDs while running on AC power rather than battery power.

Drive components and control buttons

The CD or DVD control buttons are located on the hinge bar of the computer so that you can access them whether the display panel is closed or open.

DVD-ROM drive components

If you have a DVD-ROM drive, it may look like this:

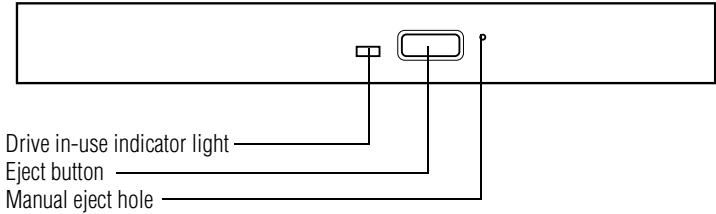

Sample DVD-ROM drive



CAUTION: Never press the eject button or turn off the computer while the drive in-use indicator light is glowing. Doing so could damage the disc or the drive.

The eject button requires power to operate. The manual eject button does not require power.



CAUTION: Never use a pencil to press the DVD-ROM manual eject button. Pencil lead can break off inside the computer and damage it. Instead, use a slim object such as a straightened paper clip.

The vent, located at the lower right-hand side of the drive, cools the DVD-ROM drive's internal mechanisms. Do not block this vent.



HINT: When the computer is off and the DVD-ROM drive is on, press the stop/eject control button on the top of the computer to eject a disc.

CD/DVD control buttons

The control buttons on the hinge bar of the computer enable you to play audio CDs when the computer is off. You can also use them to play CDs and DVDs when the computer is on.

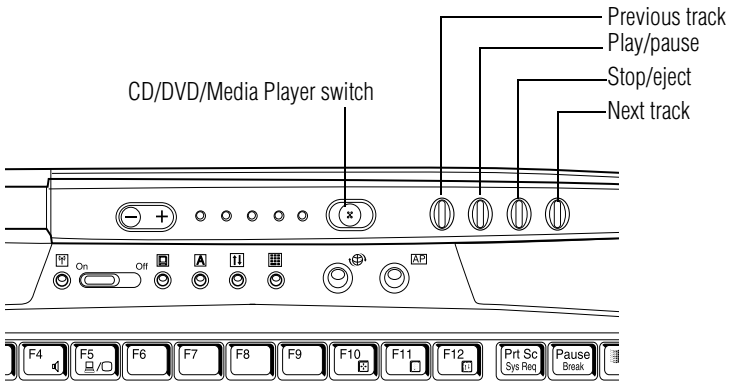

CD or DVD control buttons on the hinge bar of the computer

The **previous track button** returns to the preceding track on the disc.

The **play/pause button** starts playing the disc or pauses it if it is currently playing.

The **stop/eject button** stops a disc that is currently playing and ejects the disc.

You can eject a disc by pressing the stop/eject button twice. Use this method to eject a disc when the computer is turned off and the eject button on the front of the drive is unavailable.

The **next track button** skips to the following track on the disc.

Setting the CD/DVD/Media Player switch to CD/DVD

If the drive is empty or there's an audio CD in the drive, setting the CD/DVD/Media Player switch to the left (CD/DVD position)

turns on the sound system only. The computer remains turned off. When you open the display, Windows Media® Player turns on.

If there's a DVD in the drive, setting the CD/DVD/Media Player switch to the left (CD/DVD position), turns both the computer and the sound system on, and launches WinDVD. When you open the display, WinDVD starts playing the DVD.

Setting the CD/DVD/Media Player switch to Media Player

If the drive is empty or there's a DVD in the drive, setting the CD/DVD/Media Player switch to the right (Media Player position) turns the computer's power on and launches Windows Media® Player. When you open the display, Windows Media® Player automatically plays the default audio file (if the drive is empty), or the DVD title if a DVD is in the drive.

If there's an audio CD in the drive, setting the CD/DVD/Media Player switch to the right (Media Player position) turns the computer's power on. Windows Media® Player launches automatically and begins playing the audio CD.

Inserting a disc



WARNING: Before playing an audio CD, turn the volume down. Playing the compact disc at maximum volume could damage your ears. To turn the volume down, use the Volume Control dial or access the Volume Control program (click Start, Programs, Accessories, Entertainment, Volume Control).

- 1 If the computer is turned on, press the eject button on the DVD-ROM drive.

To play an audio CD when the computer is turned off, slide the CD/DVD/Media Player switch to the left to turn the DVD-ROM drive on, and press the CD/DVD stop/eject button twice to release the disc tray.

To locate the switch and button, refer to illustration labeled “CD or DVD control buttons on the hinge bar of the computer” on page 76.

The disc tray partially opens.



CAUTION: To avoid damaging a disc or losing data, check that the disc activity light is off before opening the disc tray.

- 2 Grasp the disc tray and pull it fully open.
- 3 Hold the disc by its edges and check that it is clean and free of dust.



CAUTION: Handle discs carefully. Avoid touching the surface of the disc. Grasp it by its center hole and edge. If you handle the disc incorrectly, you could lose data.

- 4 Carefully place the disc in the empty tray with its label facing up.

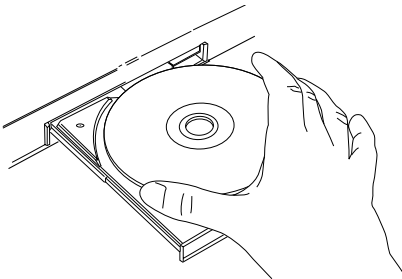

Inserting a disc



CAUTION: Be careful not to touch the drive's lens (located underneath the drive's spindle) or the area around it. Doing so could cause the drive to malfunction.

- 5 Gently press the center of the disc onto the spindle until it locks into place.

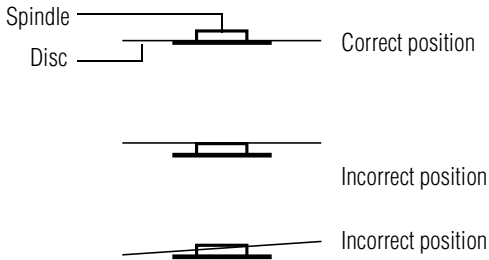

Positioning the disc on the spindle



CAUTION: Make sure the disc is properly positioned on the spindle. If you position the disc incorrectly, it can jam the disc tray.

- 6 Close the disc tray by pressing gently on the center of the tray until it clicks indicating that it is locked.

Playing an audio CD

Insert an audio CD and close the disc tray. If the computer is turned off, use the CD/DVD/Media Player switch and the control buttons on the top of the computer. Slide the CD/DVD/Media Player switch to the left to turn on the CD/DVD player, then press the play/pause button once. The CD begins to play.

If the computer is turned on, Windows Media[®] Player opens and the CD begins to play. You can use either the CD/DVD control buttons or the Windows Media[®] Player program to control the CD.

To access the Windows Media[®] Player, you can open it through the Start menu or activate it from the taskbar.



Sample Windows Media Player screen

The CD Player control panel works much like an ordinary compact disc player:

- ❖ To play the CD or to pause, click the **play/pause** button on the CD Player control panel.
- ❖ To stop the CD, click the **Stop** button.

Creating a CD

If your drive is CD-Rewritable, two programs control a drive's CD-RW features:



DirectCD™ prepares a CD-R or CD-RW disc for file read and write operations. Its icon is located on the taskbar. You can also right-click this icon to eject a disc.



Easy CD Creator™ 4 copies music to an audio CD-R or CD-RW disc, and data to a data CD-R or CD-RW disc. Its icon is located on the desktop.

For details on how to use these programs, please refer to the respective Online Help menus.

Playing a DVD

This manual has an entire chapter devoted to using WinDVD. For information about how to play back a DVD, see “WinDVD 2000” on page 163.

Viewing the contents of a CD or DVD

CDs and DVDs contain files just like diskettes and the hard disk. CDs are often used to install software or store files that require lots of space, such as photographs and large presentation files. You can use Explorer or My Computer to view the contents of any CD or DVD.

Removing a disc with the computer on



CAUTION: Check the DVD-ROM, CD-ROM, or CD-RW drive in-use indicator light when you use the DVD-ROM, CD-ROM, or CD-RW drive. Do not press the eject button, disconnect a drive, or turn off the computer while the light is glowing. Doing so could damage the CD, DVD, or drive.

- 1 Locate and press the eject button.
The disc tray partially opens.
- 2 Grasp the sides of the disc tray and pull it fully open.
- 3 Remove the disc from the disc tray and place it in its protective cover.



CAUTION: If the disc is spinning when you open the disc tray, wait for the disc to stop before removing it.

- 4 Close the disc tray by pressing gently on the center of the tray until it clicks indicating that it is locked.

Removing a disc with the computer off

- 1 Insert a slender object, such as a straightened paper clip, into the manual eject button access hole.



CAUTION: Never use a pencil to press the manual eject button. Pencil lead can break off inside the computer and damage it.

- 2 Pull the tray fully open, remove the disc and place it in its protective cover.
- 3 Push the tray in to close the drive.

Caring for CDs and DVDs

- ❖ Store your discs in their original containers to protect them from scratches and keep them clean.
- ❖ Never bend a disc or place heavy objects on top of it.
- ❖ Hold a disc by its outside edge. Fingerprints on the surface of a compact disc can prevent the drive from reading the data properly.
- ❖ Avoid exposing discs to direct sunlight or extreme heat or cold.
- ❖ To clean a disc, wipe it from the center outwards (not in a circle) with a clean, dry cloth. If necessary, moisten the cloth with water or a neutral cleaner (not benzine or rubbing alcohol). Let the disc dry completely before inserting it in the drive.

Setting up for communications

To communicate across the telephone lines with another computer, you need:

- ❖ The computer's modem
- ❖ A telephone line
- ❖ A communications program

To connect to the Internet, you need a Web browser, such as Microsoft® Internet Explorer.



TECHNICAL NOTE: Disable Call Waiting before you connect through the modem. Call Waiting interrupts data transmission.

Using the modem

The Satellite Pro 3000/3005 Series computers come with a built-in modem and 10/100 Ethernet LAN connection. To use the modem, you must connect it to a standard voice-grade RJ11 telephone line.

- 1 Attach one end of a standard RJ11 telephone cable to the modem port.

To locate the modem port, see “[Back](#)” on page 29.

- 2 Plug the other end of the RJ11 telephone cable into the modular jack of a standard voice-grade telephone line.

Connecting your computer to a network

You can connect your computer to a network locally or remotely.

- ❖ Locally, using the built-in 10/100 Ethernet LAN adapter by connecting it to a standard RJ45 LAN line.
- ❖ Remotely, using the built-in modem and a dial-up connection. For specific information about connecting to the local area network (LAN) or wide area network (WAN), consult your network administrator.

To use a dial-up connection, have your network administrator configure your computer for the network and supply you with the

telephone number for the dial-up connection. To set up the network connection, use the Dial-Up Networking Wizard:

- 1 Click **Start** and point to **Programs**.
- 2 Point to **Accessories**, then to **Communications**, and click **Dial-Up Networking**.
- 3 Enter the phone number of your network connection and let the program dial the number.

The computer connects with the network.

Powering down the computer

When you power down the computer, you have three options to choose from: Shut down, Hibernation and Standby. Each option has its advantages.



TECHNICAL NOTE: Before using any of these options to power down your computer, save your files and make sure the disk activity lights are off.

If you decide to continue working, wait a few seconds before turning the computer on again.

Shut down command

The Shut down command shuts the computer down completely. When you start up again, the computer runs a self-test and loads the operating system. You must open any programs and files you want to use.

Factors when choosing Shut down:

- ❖ No power is used while the computer is shut down. This is the most efficient mode if you will be away from your computer for an extended time.
- ❖ Restarting from Shut down uses the most time and battery power.

- ❖ When starting up again, the system does not automatically open programs and files you were previously using.

Hibernation command

Hibernation mode shuts the computer down completely, but it first saves the current state of the computer to the hard disk. Since Hibernation mode does not require power to maintain the saved information, the system settings are retained indefinitely. Restoring information from the hard disk takes longer than restoring it from memory. When you start up again, the computer runs a self-test, loads the operating system, and then returns to the state in which you left it.

Factors when choosing Hibernation mode:

- ❖ While in Hibernation mode, the computer uses no battery power.
- ❖ Because the state of the system is held on the hard disk, no data is lost if the battery discharges.
- ❖ Restarting from Hibernation mode uses less time and battery power than restarting from Shut down.
- ❖ Restarting from Hibernation mode uses a little more time and battery power than restarting from Standby because information is being retrieved from the hard disk instead of memory.
- ❖ When starting up again, the computer returns to the state in which you left it, including all open programs and files you were using.

Standby command

The Standby command puts the computer into a power-saving mode. Standby holds the current state of the computer in memory

so that, when you restart the computer, you can continue working from where you left off.

Factors when choosing Standby:

- ❖ While in Standby mode, the computer uses some battery power. The battery will eventually discharge in Standby mode. If the battery discharges, your data will be lost if you do not save your work before entering Standby mode.
- ❖ Restarting from Standby mode uses less time and battery power than restarting from Shut down or Hibernation mode.
- ❖ When starting up again, the computer returns to the mode in which you left it, including all open programs and files you were using.



NOTE: If you power down using the Standby command and the battery discharges fully, your information will be lost. Be sure to save your work first.

Using Shut down

To power down the computer using the Shut down command, click **Start**, **Shut Down**, select **Shut down** from the menu, then click **OK**.

The computer shuts down completely.

Shutting down more quickly

You can also shut down the computer by pressing the power button or closing the display panel.

To use either of these methods, you first need to turn on the feature in the Power Management utility.

- 1 Open the **Start** menu, point to **Settings**, then click **Control Panel**.

- 2 In the Control Panel window, double-click the **Power Management** icon. If the Power Management icon is not present, click **View all control panel options** on the left side of the panel.

The Power Management Properties dialog box appears.

- 3 Click the **Advanced** tab, and select the options you want.
 - ❖ **When I close the lid of my portable computer**
Set this option to **Power Off** to have the computer shut down when you close the display panel.
 - ❖ **When I press the power button on my computer**
Set this option to **Shutdown** to have the computer shut down when you press the power button.
- 4 Click **Apply**.
- 5 Click **OK**, then close the Control Panel.

Starting again after Shut down

To start the computer up again, press and release the power button. The on/off light turns on.

Using Hibernation

To power down the computer using the Hibernation option, click **Start** and select **Hibernate**, then click **OK**.

The computer saves the state of the system, including all open programs and files, to the hard disk, and then powers down completely.

Starting again from Hibernation mode

To start the computer from Hibernation mode, press and release the power button. The computer returns to the screen you were using.

If you put the computer in Hibernation mode by closing the display panel, you can start it again by pressing and releasing the power switch.

Using Standby

To power down the computer using the Standby command, click **Start, Shut Down**, select **Stand by** from the menu, then click **OK**.

The computer saves the status of all open programs and files to memory, turns off the display, and goes into a low-power mode. The on/off light blinks green to indicate the machine is in Standby mode.

Starting again from Standby

To start the computer from Standby mode, press the power button. The computer returns to the screen you were using.

If you put the computer in Standby mode by closing the display panel, you can start it again by opening the display panel.

Chapter 4

Mobile Computing

This chapter covers all aspects of using your computer while traveling.

Toshiba's energy-saver design



Toshiba is a partner in the Environmental Protection Agency's (EPA) Energy Star Program and has designed this product to meet the Energy Star guidelines for energy efficiency.

Your computer enters a low-power standby mode when it is not being used, thereby conserving energy and saving money in the process. It has a number of other features that enhance its energy efficiency.

Many of these energy-saving features have been set by Toshiba. We recommend you leave these features active, allowing your computer to operate at its maximum energy efficiency, so that you can use it for longer periods while traveling.

Running the computer on battery power

The computer contains a removable lithium ion (Li-ion) high-capacity battery that provides power when you are away from an AC outlet. You can recharge it many times.

In addition, the computer has an internal real-time clock (RTC) battery. The RTC battery powers the RTC memory, which stores your system configuration settings and the current time and date for up to a month while the computer is turned off.

Using a second battery

If you spend a lot of time traveling and need to work for many hours without an AC power source, you can fit a second lithium ion battery pack in the Modular Bay.

Battery safety precautions

- ❖ Never try to disassemble a battery.
- ❖ Never overcharge or reverse charge a battery. Overcharging will shorten its life and reverse charging could destroy it, causing the release of toxic fumes.
- ❖ Avoid touching the metal terminals of the battery with another metal object. Short-circuiting the battery will cause it to overheat and may cause permanent damage to the battery or the computer.
- ❖ Never incinerate a spent battery as this will cause it to explode, releasing toxic materials.
- ❖ If a battery is leaking or damaged, replace it immediately. Use protective gloves when handling a damaged battery.

To replace the main battery, use an identical battery which you can purchase from the accessory information shipped with your system or at toshibaaccessories.com.

Maximizing battery life

A high-capacity battery pack can be recharged many times. Over time it will gradually lose its ability to hold a charge. To maximize the life of your battery:

- ❖ Avoid leaving the computer plugged in and unused for more than a few hours. Overcharging the battery may shorten its life.
- ❖ If you are not going to use the computer for a long period of time, remove the main battery, and the secondary battery (if fitted).
- ❖ Alternate between batteries if you have a spare.
- ❖ Make sure your computer is turned off or in Hibernation mode when you are replacing a battery.
- ❖ Store spare batteries in a cool dry place out of direct sunlight.



NOTE: For optimum DVD performance, Toshiba recommends that you play DVDs while running on AC power rather than on battery power.



NOTE: Battery charge time may vary depending on the applications, power management settings, and features used.

Charging batteries

The main battery and the optional secondary battery need to be charged before you can use them to power the computer.

Charging the main and secondary batteries

To charge the main battery, plug the computer into a live wall outlet. It takes several hours to charge the battery with the computer off. It takes much longer to charge the battery while the computer is on.



TECHNICAL NOTE: The battery does not charge while the computer is consuming full power.

To charge the secondary battery, fit it in the Modular Bay and connect the computer to an AC power source.

A battery may not start charging immediately if:

- ❖ The battery is extremely hot or cold.

To ensure that the battery charges to its full capacity, wait until it reaches room temperature (50 to 80 degrees Fahrenheit, 10 to 26 degrees Celsius).

- ❖ The battery is almost completely discharged.

Leave the power connected, and the battery should begin charging after a few minutes.



HINT: Once a battery is fully charged, we recommend that you operate your computer on battery power until the battery discharges completely. Doing this extends battery life and helps ensure accurate monitoring of battery capacity.

Charging the RTC battery

The computer contains an internal battery that provides power for the real-time clock (RTC) and calendar.

During normal use, the main battery keeps the RTC battery adequately charged. Occasionally, the RTC battery may lose its

charge completely, especially if you have had the computer turned off for a long time.

If the RTC battery is low, the real-time clock and calendar may display the incorrect time and date, or stop working.

To recharge the RTC battery, plug in the computer and leave it turned off for at least 24 hours.



NOTE: When Hibernation mode is enabled and the RTC battery is completely discharged, a warning prompts you to reset the real-time clock.

Monitoring battery power



The battery light indicates the primary battery's current charge. The Modular Bay light indicates the charge state of the secondary battery (if used). In both cases, the indicator light:

- ❖ Glows green when the battery is fully charged
- ❖ Glows amber while the battery is being charged
- ❖ Does not glow if the external power source is disconnected or if the battery is completely discharged

Determining remaining battery power



NOTE: Wait at least 16 seconds after turning on the computer before trying to monitor the remaining battery power. The computer needs this time to check the battery's remaining capacity and perform its calculations.

- 1 Click **Start**, point to **Settings**, and then click **Control Panel**.
- 2 Double-click the **Power Management** icon.

- 3 Choose the **Power Save Modes** tab, then under the Running on Batteries section, click **Details**.
- 4 Click the Power Save Mode tab.

The current power source and battery power remaining section displays the current charge state of the battery. The value displays as a percentage of remaining battery charge.



TECHNICAL NOTE: The computer drains the battery faster at low temperatures. Check your remaining charge frequently if you are working in temperatures below 50 degrees Fahrenheit.

The computer calculates the remaining battery charge based on your current rate of power use and other factors such as the age of the battery.

Conserving battery power

How long a fully charged battery lasts when you are using the computer depends on a number of factors, such as:

- ❖ How the computer is configured
- ❖ How much you use the display panel instead of an external monitor
- ❖ How much you use the hard disk and other drives
- ❖ Whether you use any optional devices to which the battery supplies power, such as a PC Card
- ❖ Where you are working—since operating time decreases at low temperatures

Toshiba's power-saving options greatly increase the length of time you can use the computer before it becomes necessary to recharge the battery.

Toshiba has combined these options into three preset power usage modes:

- ❖ Long Life
- ❖ Normal
- ❖ High Power

To change the power usage mode, hold down both the Fn and F2 keys.

What to do when the battery runs low

When the battery runs low you can:

- ❖ Plug the computer into an external power source and recharge the battery.
- ❖ Put the computer in Hibernation mode and replace the battery with a charged spare.
- ❖ Save your work and turn off the computer.

If you don't manage to do any of these things before the battery completely runs out of power, the computer automatically enters Hibernation mode and turns itself off. Hibernation mode keeps track of where you were so, when you turn on the power again, you can continue where you left off.

The computer stores the information on what you were doing until the battery runs out of power. If you have Hibernation mode enabled (the default), the computer copies the details of your open programs and files to the hard disk before shutting down.

Setting battery alarms

Your computer can be configured to warn you when the battery is running low.

You can set multiple alarms. Each alarm can be set to alert you when a specified percentage of remaining battery power has been

reached. You can set how the warning occurs: sound an alarm, display a message, both, or none. You can also set the computer to enter Standby mode or Hibernation mode, or to Shutdown when the alarm goes off.

To set an alarm:

- 1 Click **Start**, point to **Settings**, and then click **Control Panel**.
- 2 Double-click the **Power Management** icon.
- 3 Choose the **Power Save Modes** tab, then under the Running on Batteries section, click **Details**.
- 4 Click the **Alarm** tab and set the alarm, as desired.

Changing the main battery

When your battery power is running low, you have two options—connect the computer to an AC power source or install a charged battery.



CAUTION: When handling a battery, be careful not to drop it or short-circuit its terminals.

Removing the battery from the computer

- 1 Save your work.
- 2 Shut down the computer or place it in Hibernation mode according to the instructions in [“Using Hibernation” on page 87](#).
- 3 Remove all cables connected to the computer.
- 4 Close the display panel and turn the computer upside down with the front side of the computer facing you.

- 5 Push and hold the battery release latch, then firmly pull the battery pack toward yourself.



WARNING: If the battery is leaking or its case is cracked, put on protective gloves to handle it, and discard it immediately following the advice in “Disposing of used batteries safely” on page 97.

Disposing of used batteries safely

You can recharge a battery many times. When the battery needs replacing, the battery light flashes amber shortly after you have fully recharged the battery.

You must discard a battery if it becomes damaged.



CAUTION: The computer’s main battery is a lithium ion (Li-ion) battery, which can explode if not properly replaced, used, handled, or disposed of. Putting spent batteries in the trash is not only irresponsible, it may be illegal. Dispose of the battery as required by local ordinances or regulations.

Use only batteries recommended by Toshiba.

The materials that came with your computer may include an insert regarding the disposal of batteries. If not, check with your local government agency for information on where to recycle or dispose of old batteries.

Traveling tips

The environmental precautions listed in “Selecting a place to work” on page 41, also apply while traveling.

- ❖ Never leave your computer on a sunny ledge or in a place where it could get wet or covered in dust.

- ❖ Always travel with the computer in a carrying case. Toshiba offers a choice of carrying cases for the computer. They all provide plenty of extra space for manuals, power cables, compact discs and diskettes. Contact your authorized Toshiba representative for more information.
-



TECHNICAL NOTE: When traveling by air, you may be required to pass your notebook through airport security equipment. The X-ray equipment will not harm your computer.

Chapter 5

Getting to Know the Windows[®] Millennium Edition Operating System

This chapter introduces the Windows[®] Millennium Edition operating system by guiding you through a few basic tasks.

If you have used the Windows[®] 98 operating system before, you will find the Windows[®] Millennium Edition operating system familiar, since both operating systems are similar. Whether you have used a Windows[®] operating system or not, the skill and confidence you will gain from this chapter will more than offset the short amount of time spent going through these lessons.

As you explore your computer's operating system further, you will often discover alternative ways of accomplishing a particular task.

For more detailed information on your operating system, refer to the Microsoft[®] Windows[®] Millennium Edition operating system documentation that came with your computer.

Lesson 1: Exploring the desktop

The desktop is the launching pad for everything you can do in the Windows® Millennium Edition operating system. You use its features to start programs, find documents, set up system components, and perform most other computing tasks.



HINT: The illustrated examples in this guide may appear slightly different from the screens displayed by your system. However, the differences are not significant and do not indicate any change in the functionality of your system.

Finding your way around the desktop

Your computer's desktop includes several standard features: icons, Start button, shortcut tray, taskbar, system tray, and background pattern.

Icons

An icon represents a folder, file, or program that can be quickly activated by double-clicking the icon.

You can create a new desktop icon for any folder, file, or program by dragging the element's icon from its location in a window to the desktop area.

The icons initially displayed on your system desktop include:



My Documents—Provides a convenient place to store documents, graphics, or other files you want to access quickly.



My Computer—Shows the file system for your computer and network (if any).



Recycle Bin—Holds files you've deleted using the Windows Explorer. You may retrieve these files until you empty the Recycle Bin.



TECHNICAL NOTE: If you delete a file from a diskette, it does not go into the Recycle Bin. For more information on the Recycle Bin, see Windows online Help.



Internet Explorer—The Microsoft browser that provides access to the Internet.



Toshiba VirtualTech—A Toshiba utility to help answer technical questions and troubleshoot system problems. For more information about VirtualTech, see [“Using VirtualTech” on page 220](#).



Toshiba Software Offer—A service provided by Toshiba that offers additional software.



FreedomWare™—Free offers and discounts on hardware and software for your notebook computer.



NOTE: If you place the cursor over an icon, a popup description of the file contents appears.

Your desktop may contain other icons depending on your configuration. See Windows® Millennium Edition online Help for more specific information on each icon and how to use it.

Start button

You use the Start button to:

- ❖ Start programs
- ❖ Access Microsoft® Windows® Millennium Edition operating system update information

- ❖ Open recently accessed documents
- ❖ Adjust system settings
- ❖ Search for files
- ❖ Access Windows Help and Support
- ❖ Run programs
- ❖ Suspend system activity and shut down the computer

For more information on starting programs, see [“Lesson 6: Starting programs”](#) on page 110.

Shortcut tray

The Shortcut tray displays icons of tasks or programs. These icons function much like the desktop icons, but are easily accessible even when the desktop is covered with open windows.

To activate a task or program, click the appropriate Shortcut tray icon.

To add an icon to the Shortcut tray, click the icon and drag it to the Shortcut tray.

Taskbar

Each time you open a program, a button associated with that program appears on the taskbar. With some programs, a button appears on the taskbar for each document or window you open. You can use these buttons to quickly switch between the programs or windows.

To make a program or window the active one, click the program’s or window’s button.

System tray

The System tray displays icons of tasks or programs that run continuously in the background. To learn more about each task,

position the cursor over the icon for a few moments and a short description of the task appears.

Typical tasks in the System tray are Current time, Power usage mode, and speaker volume.

To activate a specific task, double-click the appropriate System tray icon.

Windows® Millennium Edition file system

All files on your computer are organized for accessibility using a hierarchal file system.

Programs, documents, and other data are held in *files*. These files can be grouped together in *folders*, and folders can be grouped inside other folders for convenient organizing. All the files and folders reside in your computer on a storage *device*, such as a disk drive.

You can think of your computer storage system in terms of office equipment. You have a file cabinet (device), that contains folders, and each folder may contain documents. Your office may have more than one file cabinet, just as your computer may have more than one disk drive.

Computers can be connected together to form a *network*, so that programs, documents and other data can be quickly and easily shared between computers.

You can use the My Computer feature on the desktop to access any file in the Windows file system.

For more information, read the Microsoft documentation that comes with your computer.

Lesson 2: Using the AccuPoint II

The “Getting Started” chapter introduced you to the AccuPoint II pointing device, which is your basic tool for moving around the

screen and performing computing tasks. This lesson lets you practice using the AccuPoint II pointing device.

- 1 Move the pointer to the **Start** button, then click the primary button (the larger one) to open the Start menu.



NOTE: In this guide, the term “click” refers to the primary button, which is the larger one. Instructions requiring the secondary button specifically mention that button. For example, “click the secondary button.”

- 2 Click an empty area of the desktop to close the Start menu.
- 3 With the pointer in an empty area of the desktop, click the secondary button (the smaller one) to open the desktop shortcut menu. As the name implies, shortcut menus provide quick access to many Windows[®] Millennium Edition operating system features.



Sample desktop shortcut menu

- 4 Click an empty area to close the shortcut menu.
- 5 Use the pointer button in the center of the keyboard to move the pointer to the **My Computer** icon, then click the primary button twice rapidly. (This process is known as “double-clicking.”)

The My Computer window opens.

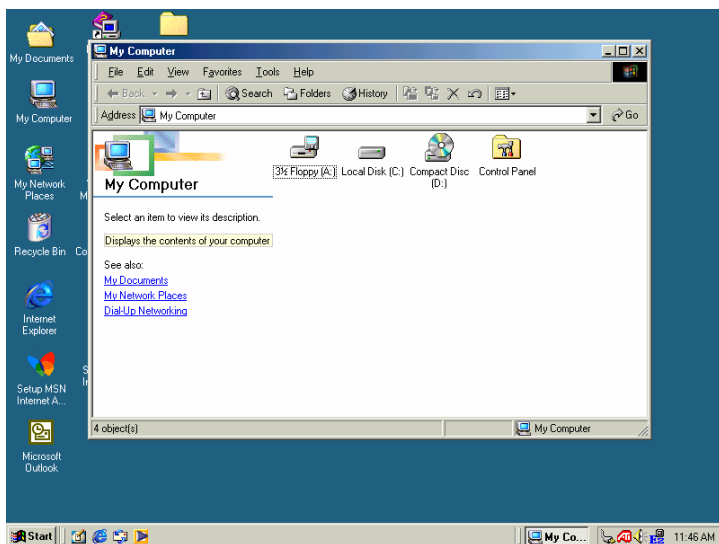

Sample desktop with the My Computer window open



- 6 Now click the **Close** button in the upper-right corner of this window.

The My Computer window closes.

- 7 Click an empty area of the taskbar at the bottom of the screen and, while holding down the primary button, use the pointing device to drag the pointer to the right edge of the desktop, then release the primary button. This process is known as “clicking and dragging.”

The taskbar moves from the bottom to the right edge of the desktop.



Sample desktop with the taskbar on the right



HINT: You can move the taskbar to any of the desktop's four edges.

- 8 Click the taskbar once again and drag it back to the bottom of the desktop.

Lesson 3: Learning about the Internet

This lesson begins with Windows[®] Millennium Edition Web Tutorial. It demonstrates how to access a Web page from a window and from the taskbar.

The lesson assumes you have an account with an Internet Service Provider (ISP).

Exploring the Web Tutorial

Microsoft's Web Tutorial can answer questions about the Internet.

1 Click on the **Connect to the Internet** icon on your desktop.
The Internet Connection Wizard appears.

2 Follow the Wizard's steps to connect.

3 In Internet Explorer, click **Help**.
The Help menu appears.

4 Click **Tour**.

Internet Explorer displays a page with information about how to use Internet Explorer.

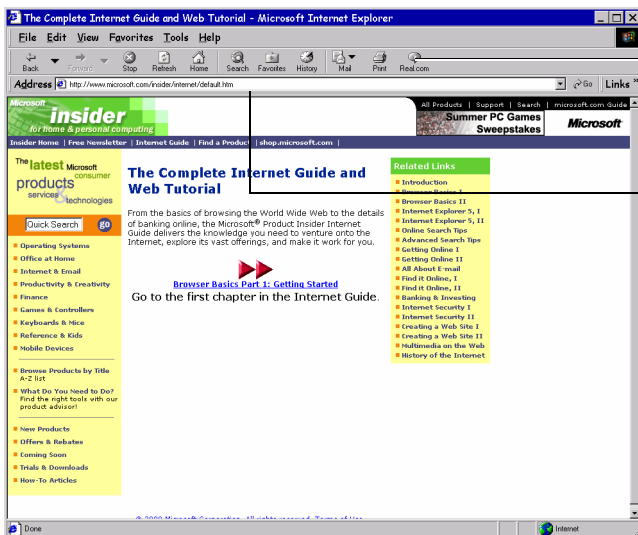

Sample Web page from the Tutorial



HINT: The content on the Web Tutorial may be different from the content in this illustration. The information on Web pages is dynamic and can be changed at any time.

- ❖ The Browser controls provide various navigation features.
- ❖ The Internet address, also called a Uniform Resource Locator (URL), is a line of information telling the browser where to look for a specific Web page.
- ❖ The large window contains the Web page itself.

Lesson 4: Creating a new document

This lesson teaches you how to create a text file without having to first open a program.

- 1 Move the pointer to an empty area of the desktop, then click the secondary button.

The operating system displays a shortcut menu of commands applicable to the desktop.

- 2 Click **New**, then click **Text Document**.

The operating system creates an icon on the desktop called New Text Document with the icon name highlighted.

- 3 To give your document a meaningful name, type My New Doc.txt and press Enter.

- 4 Double-click the **My New Doc** icon.

The operating system opens the new document in Notepad—the text editor built into the Windows[®] Millennium Edition operating system.

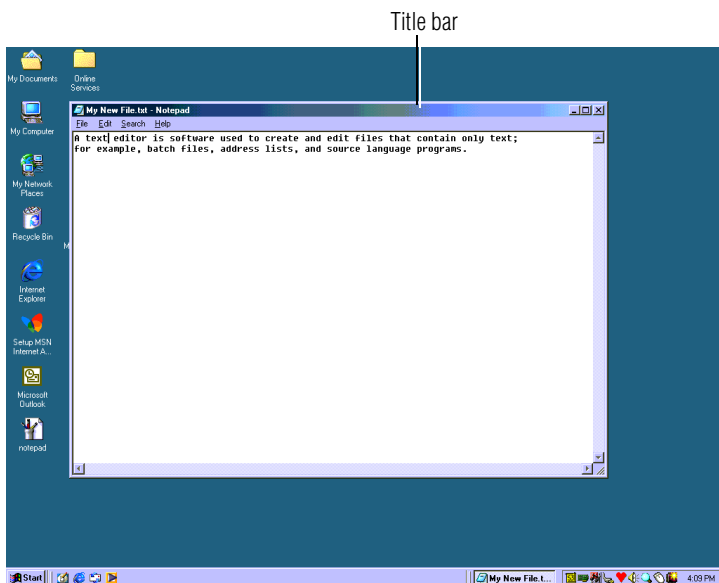

Sample Notepad window

Notice that when the document opens, there is a new button on the taskbar that reads My New File- Notepad (the name may be too long to fit into the taskbar space but, if you point to the name, the complete name is visible). By displaying buttons like this one, the taskbar helps you keep track of the programs and files you currently have open.

To learn more about Notepad, click **Start**, then click **Help** or open the Help menu by pressing F1. For now, leave Notepad open and go on to the next lesson.

Lesson 5: Creating a new folder



DEFINITION: A folder is an area where you can store documents and other types of files. It is analogous to a file folder stored in a file cabinet. In this case, a disk drive in the computer is the file cabinet.

The Windows[®] Millennium Edition operating system stores documents and programs in folders. It even stores other folders in folders. In this lesson, you will create a folder in which to store your new document.

- 1 Move the pointer to an empty area of the desktop, then click the secondary button.

The operating system displays the desktop shortcut menu.

- 2 Click **New**, then click **Folder**.

The operating system creates an icon on the desktop called New Folder with the icon name highlighted.

- 3 Type a name for the folder, such as **My Folder**, then press Enter.



- 4 Close the Notepad document you just created by clicking the **Close** button on the right side of the Notepad title bar.

The operating system displays the document as an icon on the desktop.

- 5 Click the document icon and drag it toward your New Folder icon. Position the document icon over the New Folder icon until it changes color, then release the primary button.

The outline of the document icon moves across the desktop and disappears into the folder.

- 6 To see your document, double-click the folder icon.

A window opens and displays the contents of the folder.



- 7 Close the window by clicking its **Close** button and continue with the next lesson to learn how to start programs.

Lesson 6: Starting programs

Usually, you will know which program you want to use for a particular task.

This lesson teaches you how to launch programs from the Start menu, using two of the programs that are built into the Windows® Millennium Edition operating system: Paint and Windows Explorer.

- 1 Click **Start**, then point to **Programs**.

The operating system displays a list of program folders.

- 2 Point to **Accessories**, then click **Paint**.

The operating system opens Paint—a basic drawing program.

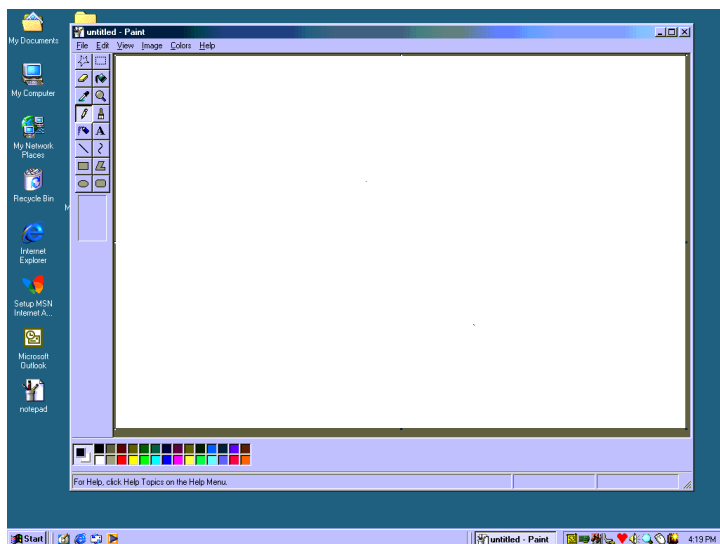

Sample Paint program open on the desktop

- 3 To open the second program, click **Start**, then click **Programs**.

- 4 Point to **Accessories**, then click **Windows Explorer**.

The operating system opens Windows Explorer, which provides access to all your computer's resources. For example, it lets you see all the files in a particular folder on the computer's hard disk.

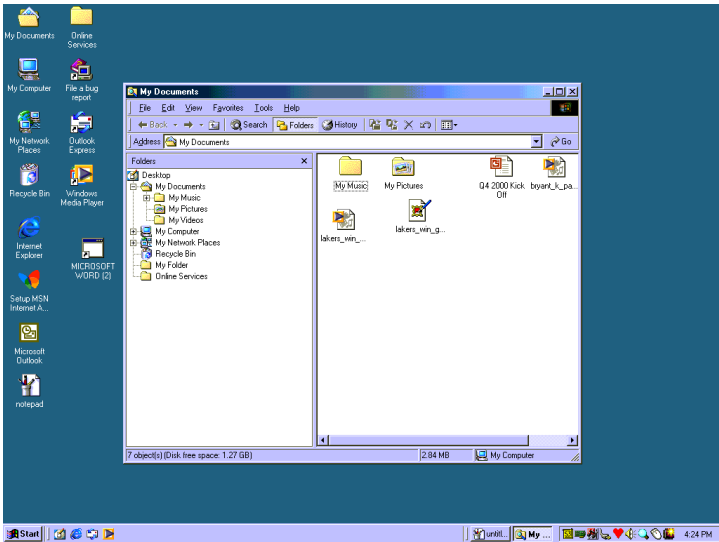

Sample Windows Explorer open on the desktop

Notice the taskbar now has two buttons on it—one for Paint and one for Windows Explorer.

5 Click the **Paint** button on the taskbar.

The operating system displays the Paint program.

The Windows[®] Millennium Edition operating system places the active window on top of other windows on the desktop unless you have selected a different display option. You can move back and forth between the two programs by clicking each button alternately.

Lesson 7: Resizing, repositioning, and hiding windows

If you have followed the lessons in this chapter, you now have a screen with several program windows open. You can organize these windows by resizing and repositioning windows so that you can see more than one of them at a time. You can also hide

windows by removing them from the desktop without actually closing your document or program.

This lesson introduces several ways to adjust the size, shape, and position of windows open on the desktop.

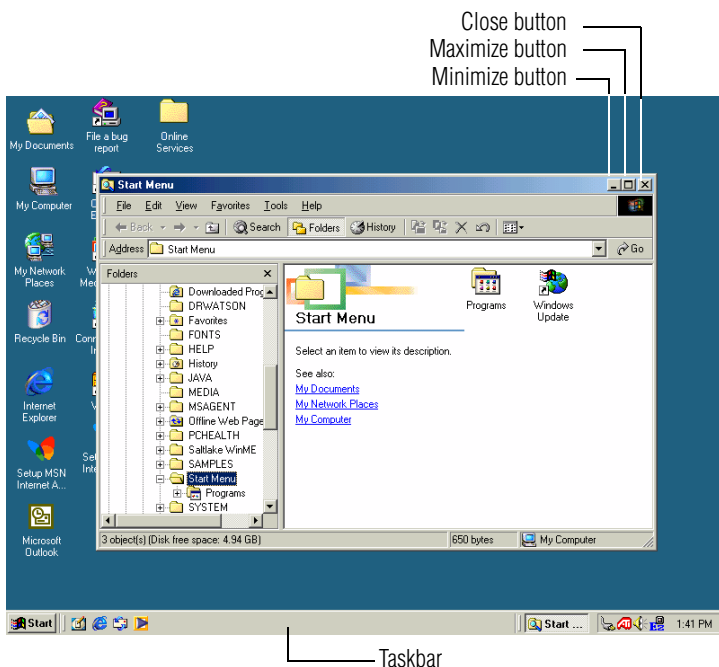

Sample Windows Explorer open on the desktop

Using the taskbar

If you have applications open on the desktop, you can rearrange them by pointing to the taskbar with the AccuPoint II pointing device and clicking the secondary button. You have these options:

- ❖ Move windows
- ❖ Size windows
- ❖ Minimize all windows—display only the taskbar buttons

- ❖ Maximize windows
- ❖ Close windows

Choose your option depending on how you wish to set up your desktop.

Minimizing and maximizing windows

- 1 To make the Windows Explorer window the active window, click the **Windows Explorer** button on the taskbar.

The operating system highlights the Windows Explorer title bar to show that Windows Explorer is the active window.



- 2 Click the **Minimize** button at the top-right of the Explorer window to hide the window.

Windows Explorer disappears from the desktop. However, it is still open, as you can see from the taskbar.



HINT: Minimizing program windows is a good way to clean up the desktop without actually closing programs.



- 3 Click the **Maximize** button in the top-right corner of the Paint window.

The Paint window expands to fill the screen, hiding everything except the taskbar. Notice that the Maximize button has changed. It is now called the Restore button.



HINT: Maximizing a program is a good way to work when you are only using that program and do not want any distractions on the screen.

Resizing and moving windows



- 1 Click the **Restore** button in the top-right corner of the Paint window.

Paint returns to its previous size and location. Notice that the Restore button has changed back into the Maximize button.

For the next few steps assume that you want to be able to see both Paint and Windows Explorer at the same time.

- 2 Move the pointer to the right-hand edge of the Paint window.

The pointer changes to a two-headed arrow.

- 3 Click and drag the edge of the window until it takes up just less than half the width of the desktop.

- 4 Click the title bar of the Paint window and drag it to the left side of the desktop.

You can move any window by clicking its title bar and dragging it.

- 5 Click **My Documents** on the taskbar.

- 6 Repeat steps 3 and 4 to change the size and position of Windows Explorer, placing it on the right side of the desktop.

Now that the windows are side by side, you can see how you could refer to one window while working in the other.

Resizing and moving windows allows you to rearrange the desktop to suit your needs. Experiment with different sizes and placements of windows to find the best arrangement for your work.

At this point you have two programs open on the desktop. The next lesson shows you how to close them.

Lesson 8: Closing programs

Once you are finished working with a document or program, it is a good idea to close it. While you can run several programs at the same time, having a large number of programs and documents open simultaneously can slow down your computer.

This lesson teaches you how to close the programs you opened earlier in this tutorial.

To close the programs:



- 1 Click the **Close** button at the top-right of the Explorer window.

That is all there is to it. Windows Explorer closes, removing the Explorer button from the taskbar as well.

- 2 Close Paint and the My Computer window (assuming it is still open) by clicking the **Close** buttons for each program.



HINT: Always save your work before you close a program.

Lesson 9: Creating shortcuts

By adding shortcuts to your desktop, you can open programs or files with the click of a button. You will probably want to create shortcuts for the programs you use most frequently. This lesson explains how to create shortcuts using two Windows[®] Millennium Edition accessories, Calculator and Character Map, as examples.

Creating a shortcut to the Calculator

Use this method when you know the name and location of the program file to which you would like to create a shortcut.

- 1 Move the pointer to an empty area of the desktop, then click the secondary button.

The operating system displays the desktop shortcut menu.

- 2 Click **New**, then click **Shortcut**.

The operating system displays the Create Shortcut dialog box.

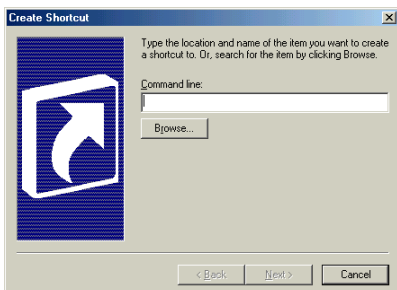

Sample Create Shortcut dialog box

- 3 In the **Command line** box, type `c:\windows\calc.exe` and click **Next**.

The operating system prompts you to select a name for the shortcut.

- 4 Type Calculator and click **Finish**.

The operating system displays the new shortcut on your desktop.

Creating a shortcut to the Character Map

Use this method when you don't know the name and location of the program file.

- 1 Click **Start**, then point to **Search**.

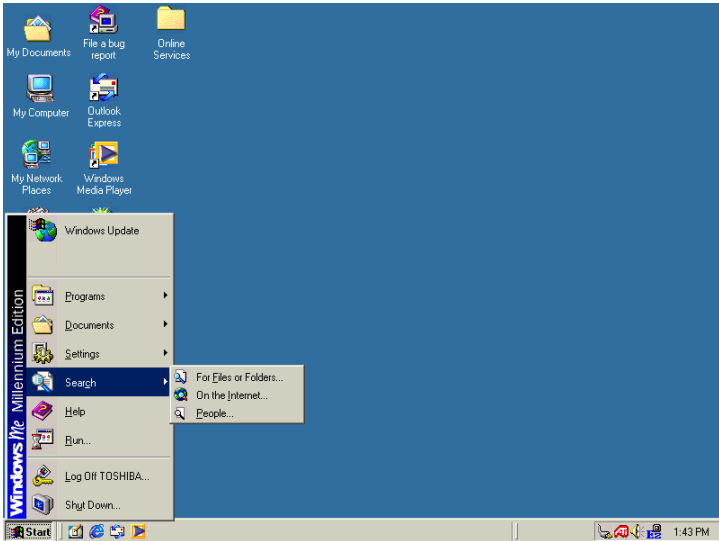

Sample Search options on the Start menu

2 Click Files or Folders.

The operating system displays the Search Results dialog box.

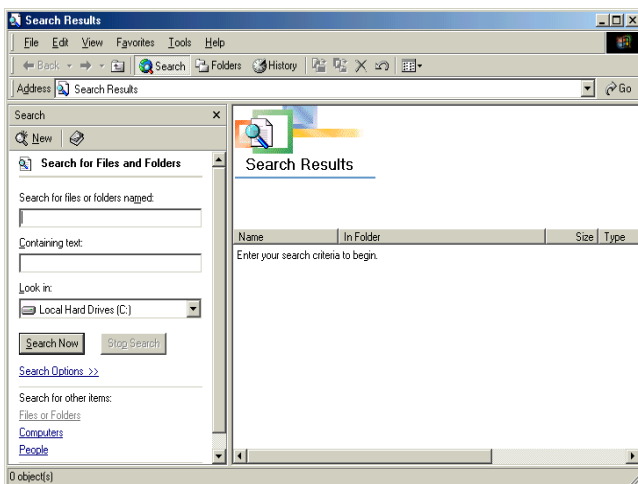

Sample Search Results dialog box



HINT: Search also allows you to perform searches on the Internet.

- 3 Type char in the **Search for files or folders named:** text box, and then click **Search Now**.

The operating system displays a list of all the files with “char” in their names.

- 4 Click the **Character Map** file with the secondary button and drag it to the desktop.

A shortcut menu appears.

- 5 Click **Create Shortcut**.

A shortcut to the Character Map appears on your desktop.

Clicking a shortcut icon opens the program or folder immediately. You can place as many shortcuts on your desktop as you find useful.



HINT: The Character Map is a useful tool when you want to add a special character to a document.

Lesson 10: Changing the screen saver

You can personalize the background area of your desktop with pictures, patterns, or colors. The background is considered a “property” of your desktop. This lesson will not only teach you how to change the background, but will also introduce you to properties.

The Windows[®] Millennium Edition operating system treats all windows, icons, programs, drives, etc. as self-contained objects, each with its own set of properties (such as size, position on-screen, and color). Many of these properties can be customized to meet your particular needs and tastes.



DEFINITION: An object is an independent block of data, text, or graphics that was created by an individual application.

This lesson introduces object properties by showing you how to change one of the properties of the desktop—the screen saver. This is a continuously changing pattern that appears on the screen during pauses in your work.

- 1 Move the pointer to an empty area of the desktop, then click the secondary button.

The operating system displays the desktop shortcut menu.

- 2 Click **Properties**.

The operating system opens the Display Properties dialog box.

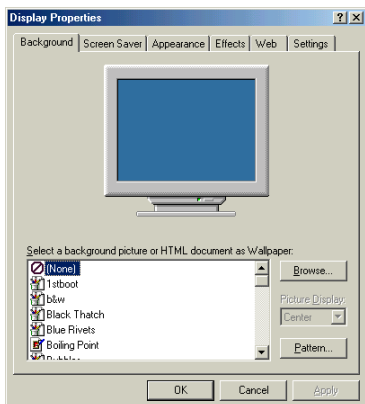

Sample Display Properties dialog box

- 3 Click the **Screen Saver** tab.
- 4 Click the arrow beside the current option—probably “(None)”—to open the screen saver list box.
- 5 Scroll through the screen saver options by clicking the scroll arrows in the list box.
- 6 Try a screen saver pattern by clicking a name in the list box.
The operating system displays your selection in the monitor above the list box. Try several patterns.
- 7 To apply a pattern to your desktop, click **Apply**.
- 8 After you have chosen a screen saver pattern and applied it to your desktop, click **OK**.

The operating system returns you to the desktop.

You can view any object’s properties by clicking the object with the secondary button, then choosing **Properties** from the shortcut menu that appears.

The next lesson explains how to set two other properties—the date and time.

Lesson 11: Setting the date and time

You initially set the computer's date and time properties when you turned the computer on for the first time and set up the Windows[®] Millennium Edition operating system.

To change the date and time settings:

- 1 Click **Start**, then point to **Settings**.
- 2 Click **Control Panel**.

The operating system displays the Control Panel.

- 3 Double-click the **Date/Time** icon.

The operating system displays the Date/Time Properties dialog box.

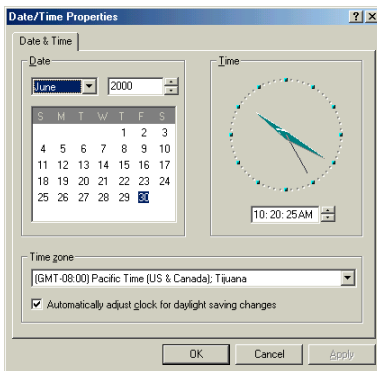

Sample Date/Time Properties dialog box



HINT: To open the Date/Time Properties dialog box more quickly, either click the time display on the taskbar with the secondary button, then click Adjust Date/Time, or double-click the time display.

- 4 Set the correct month, year, day, and time.
- 5 Click the **Time zone** drop-down list box and set your time zone.
- 6 Click **OK**.

Continue with the next lesson to finish cleaning up the desktop.

Lesson 12: Removing objects from the desktop

Earlier in this tutorial, you created a new icon on the desktop. Since everything you have done to this point has been just practice, you may want to return the desktop back to its original uncluttered state. This lesson explains how to remove objects from the desktop and introduces the Recycle Bin.

- 1 Click the **New Folder** icon you created, drag it until it is over the Recycle Bin icon and it changes color, then release the primary button.

The icon disappears. But, with the Windows[®] Millennium Edition operating system, it is not really gone. It is merely set aside in the Recycle Bin so that you can restore or delete it later.

- 2 Repeat step 1 for any other icons you created during this tutorial.

Each icon disappears as you drop it on the Recycle Bin.

- 3 Double-click the **Recycle Bin** icon.

The operating system opens the Recycle Bin window. Notice that all the icons you dropped on the Recycle Bin are listed.

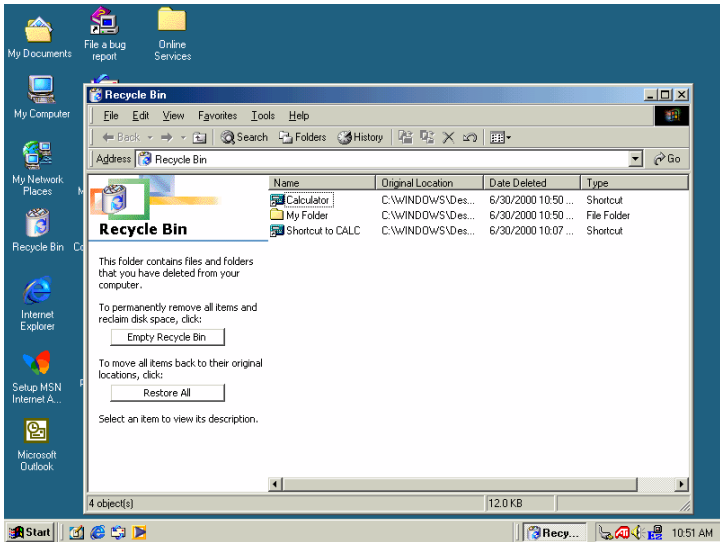

Sample Recycle Bin open on the desktop

- 4 To completely remove an object, select it, and then click **File, Delete**.

The object is permanently deleted from the Recycle Bin.

Later on—in your real work, not in this tutorial—you will use the Recycle Bin to delete other objects such as folders, documents, and sometimes even programs. Still, the process is the same. Just drag an object's icon to the Recycle Bin.

If you change your mind and want to restore an object you sent to the Recycle Bin, select the object with the secondary button and click **Restore**. The operating system restores the object to the place from which it was deleted.

When you are absolutely certain that you never want to see it again, delete it from the Recycle Bin.

To delete everything from the Recycle Bin at once, choose **Empty Recycle Bin** from the File menu.



HINT: Empty the Recycle Bin periodically. Even though an item is moved to the Recycle Bin, it still uses valuable space on the hard disk drive until it is deleted from the Recycle Bin.

Lesson 13: Using System Restore

The System Restore feature allows you to return your computer to the way it was configured on a specific date or time, a “restore point.” This is useful if you are reconfiguring your computer for new hardware or software. In the event that your hardware or software causes your computer to malfunction, you can remove the offending item(s) and restore the system to the state it was in at the preset time.

To get to System Restore, click **Start**, point to **Programs**, **Accessories**, **System Tools** and click **System Restore**.

The System Restore Welcome screen appears.

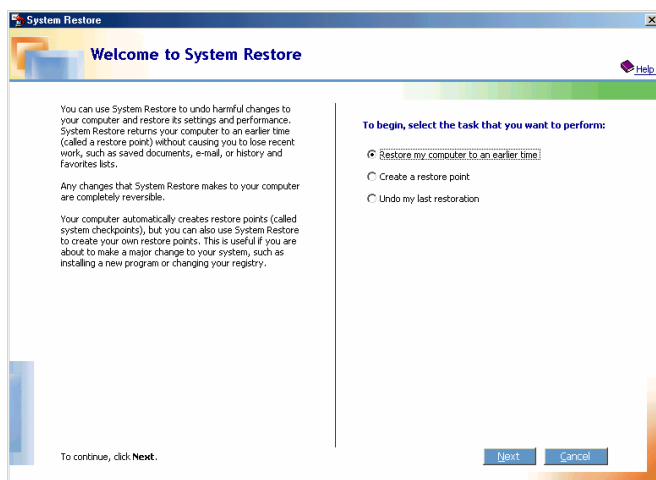

Sample System Restore Welcome screen

The Windows[®] Millennium Edition operating system guides you through the process of storing your system settings for future use. It also guides you through restoring your system to the selected date or time.

Lesson 14: If I am lost, what do I do?

This lesson teaches you how to use some of the Help features in Windows[®] Millennium Edition operating system.

Windows[®] Millennium Edition Help

The Windows[®] Millennium Edition operating system has a Help facility. If you cannot figure out how to do something, the answer is probably only a few clicks away.

Assume that you want to draw a picture, but don't know how.

- 1** If you have an application open, press F1, otherwise click **Start**, then click **Help**.

Windows Millennium Edition opens the Help and Support window.

- 2** If you do not see the index, click **index**.
Help and Support displays the Index.

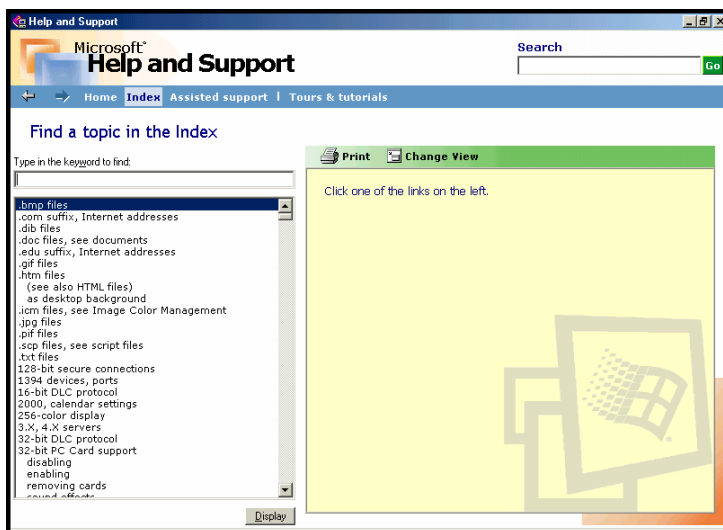

Sample Help and Support Index

The left side of the screen contains the index. The text box above the index, where the cursor is flashing, lets you type in a topic you want to find in the index.

3 Type pictures in the text box.

Notice as you type that the index moves to locate what you typed. When you type the letter p, the topic list moves to the first entry that begins with P, and so on.

There are a number of topics listed under Picture. One of them, **creating, editing with Paint**, looks promising.

4 Double-click **creating, editing with Paint**.

Help opens a topic screen that gives a brief description of how to draw pictures, including an icon to start the Paint program.

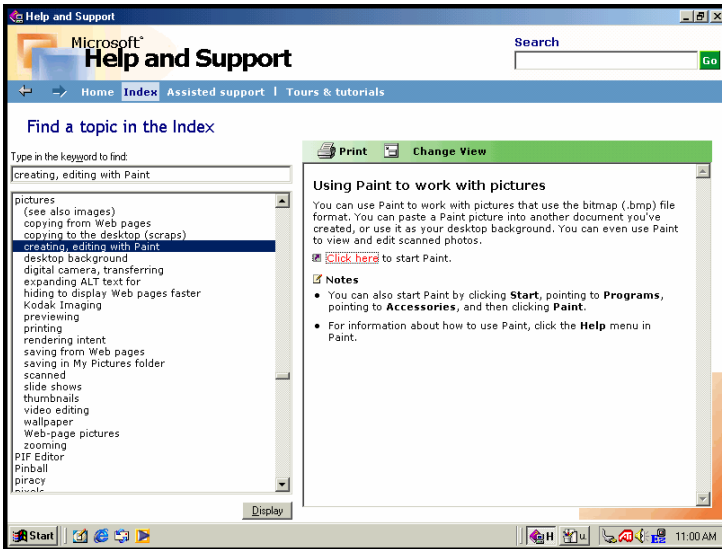

Sample Drawing help window

5 Click the **Click Here** link.

The operating system opens the Paint program.

Not every Help topic contains a hot link to start the program it is talking about. However, when you do encounter one, it provides a convenient way to start the program to look at it while you read about the program in the Help topic.

Using the online tours and tutorials

Whether you are new to computers or you have some experience, the Windows[®] Millennium Edition Tours and Tutorials collection is a good place to start.

If you are not familiar with either the Windows[®] 98 or Windows[®] Millennium Edition operating system, start with “Windows Millennium Edition Preview.”

If you have used the Windows[®] 98 operating system, “Learning about the benefits of Windows Me features” is a helpful

introduction to the new features in the Windows[®] Millennium Edition operating system.

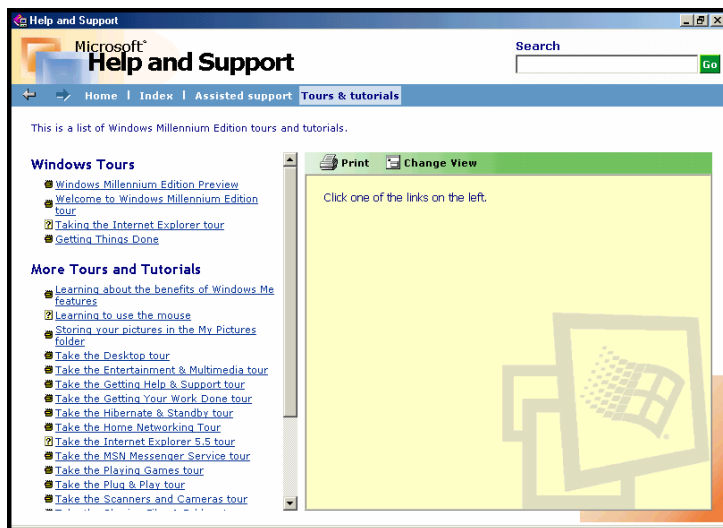

Sample Windows[®] Millennium Edition Tours and tutorials window

To start a Windows[®] Millennium Edition tour or tutorial:

- 1 Click **Help**, then click **Tours and tutorials**.

The Microsoft[®] Help and Support window takes you to the Tours and tutorials section.

- 2 Scroll through the list of Tours and tutorials and select the place you want to start.
- 3 Click the selected topic and follow the instructions on the screen.

Lesson 15: Turning off your computer

It is very important that you let the Windows[®] Millennium Edition operating system shut down your computer. As it shuts down, the operating system performs a number of tasks that ensure that everything is in place the next time you turn on the computer. This

lesson teaches you how to shut down the operating system and turn off your computer.

- 1** Click **Start**, then click **Shut Down**.

The operating system displays the Shut Down Windows dialog box.

- 2** Select **Shut down**, then click **OK**.

The operating system displays a message that it is shutting down and turns off the computer.

There are other ways to shut down your computer. For more information, see [“Powering down the computer”](#) on page 84.

Chapter 6

Exploring Your Options

In this chapter, you will explore other features of your notebook computer.

Windows[®] Millennium Edition special features

The Windows[®] Millennium Edition operating system offers you several new features and enhancements, including:

- ❖ New system file protection
- ❖ A system restore function, allowing you to rollback the system to its previous mode
- ❖ An improved help center, support automation, and automatic Windows update
- ❖ Wizards to simplify setting up your home network
- ❖ Ability to share one Internet connection among multiple PCs
- ❖ An automatic discovery feature that allows your computer to detect new and intelligent devices

Personalizing your desktop

Your desktop is your virtual workspace. This section explains how to customize its features for the way you like to work. You can customize the following aspects of the desktop:

- ❖ Taskbar—which resources to display for quick access
- ❖ Active Desktop™—what information from the Internet to always display
- ❖ Desktop style—how windows are displayed and how to browse folders and files
- ❖ Toolbars—what information appears at the top of each window

Customizing the taskbar

As you work, the taskbar changes to reflect what you are doing. Its icons provide shortcuts to programs, documents, files, folders, system features, and components. Open applications also have Forward and Backward buttons to allow navigation through folders, documents, and Web sites.

For example, you can personalize the taskbar to include not only Quick Launch icons, but also your favorite URL addresses or local folders and programs.



DEFINITION: URL stands for Uniform Resource Locator, which is the address that defines the route to a file on the Web or any other Internet facility. Generically, it is known as the World Wide Web site address.

Having a list of favorite URLs handy saves time. Using it bypasses the need for you to launch your browser first.

To access all taskbar options, point to an empty space in the taskbar and click the secondary button to customize your setting.

Bringing the world to your desktop

With the Windows[®] Millennium Edition operating system you can set up your desktop with complete World Wide Web integration at a single click. As Microsoft[®] Help says, “The Active Desktop interface lets you put ‘active content’ from Web pages or a channel on your desktop. You can make your desktop truly your own space by adding the active items you refer to on a regular basis: news, weather, sports, stock prices or whatever you want to have at hand.”

Turning on the Active Desktop™ interface

The first step to bring active content to your desktop is to turn on the Active Desktop™ interface:

- 1 Point to an empty space on the desktop and click the secondary button.
- 2 Point to **Active Desktop**, then click **Show Web Content**.
Your desktop is ready to set up.

Adding components to the Active Desktop™ interface

- 1 Point to an empty space on the desktop, click the secondary button, and click **Properties**.
- 2 Click the **Web** tab.
The operating system displays a list of items to add to the desktop.
- 3 Click **Show Web Content** on My Active Desktop.
- 4 To view additional components, click **New**.
The New Active Desktop Item dialog box appears.

- 5 To browse the Active Desktop Gallery for more components to add, click **Visit Gallery**.

In order to browse, an active Internet connection must be established.

- 6 To select some other Web site, type the address of the Web site you want or click **Browse** to locate it.

You can configure the Active Desktop™ interface in several other ways. For further information, see your Windows® Millennium Edition operating system documentation or access Windows® Help by clicking **Start**, and then **Help**.

Changing desktop and browsing style

The Windows® Millennium Edition operating system provides several ways to view your desktop and browse the files and folders on your local computer or network file server.

You can choose from three different styles:

- ❖ Web style
- ❖ Classic style
- ❖ Custom style

The style you choose determines how you browse in the Windows® Millennium Edition operating system, regardless of whether you start from the desktop, My Computer, Windows Explorer, or Internet Explorer.

For more information about changing your desktop style, enter customizing the desktop on the Index tab in Windows® Help.

Working in Web style

You can work in Web style if you prefer to organize and browse your computer using these Web-like options:

- ❖ Single-click to browse the desktop and folder.

You click only once to open an item, just as you click a Web link to jump. Similarly, you point to items to select them.

- ❖ Show Web page backgrounds in individual windows.

You can display Web pages, or any HTML page, as background in a window. In Web style, any folder with HTML content that is displayed as a Web page can include artwork, Microsoft Office documents, multimedia, interactive forms, and so on. Some windows—such as My Computer and Control Panel—come with a background that displays a description of each feature when you point to its icon.



DEFINITION: Hypertext Markup Language (HTML) is a special coding scheme used to prepare text and graphics for access over the World Wide Web.

Working in Windows 95 Classic style

The Classic style resembles the Windows[®] 95 operating system desktop. Using this option, you double-click to open items, and each item opens in a separate window.

Working in Custom style

You can pick and choose which options you want. Custom settings include options for browsing folders, creating window backgrounds, and selecting and opening items. For example you can use options from both the Web style and the Classic style so you can double-click to open items and use Web pages as window backgrounds.

Choosing a style

To select the desktop style and browsing option:

- 1 On the desktop, double-click **My Computer**.

The My Computer window appears.

- 2 On the **Tools** menu, click **Folder Options**.

The Folder Options dialog box appears.

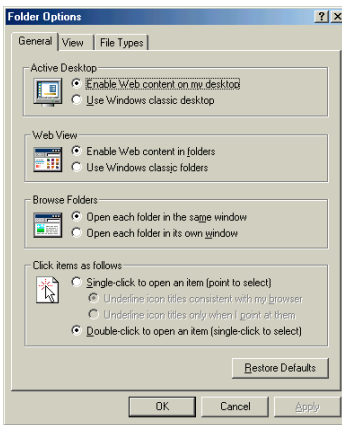

Sample Folder Options

- 3 Click the style you want to use, then click **OK**.

Personalizing individual windows

Just as you can display a Web page on your desktop, you can also display a Web page in an individual window. If you subscribe to the Web page, it can be automatically updated on a regular basis. For example, using this Web integration feature you can monitor weather, game scores, stock prices, or headlines—all in the window of your choice.

Adding a background to a window

If you select art or a Web page as a window background, set your desktop style to Web style—or select the **As Web Page** option from the View menu.

To add a background to a window:

- 1 Open the window you want to customize.
- 2 On the **View** menu, select **Customize this folder**, and follow the prompts.

Customizing window toolbars

You can display one or more customizable toolbars at the top of a window. As you browse, the Windows® Millennium Edition operating system detects the kind of information presented in the window and automatically displays the appropriate toolbar buttons and menus.

You can also add these toolbars to the taskbar.

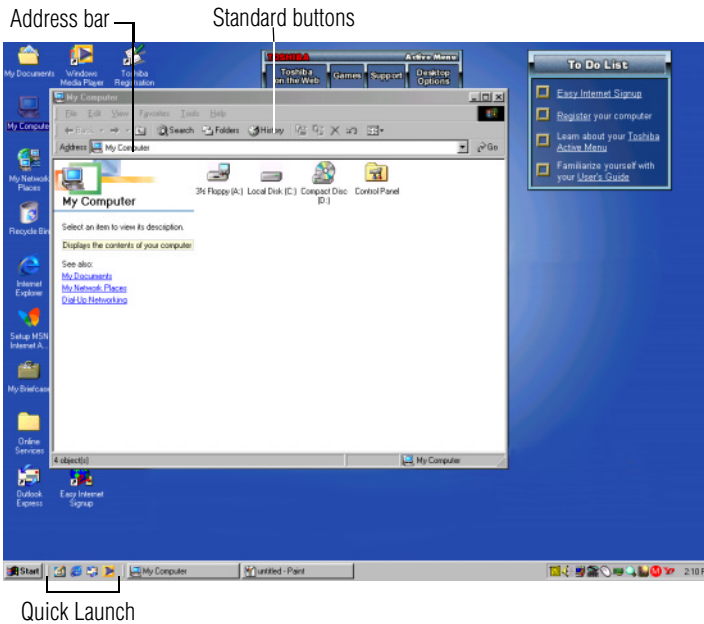

Sample toolbar locations

The elements you can add to the top of the window are:

<i>Toolbar element</i>	<i>Description</i>
Address Bar	Opens Web pages, programs, folders, or documents. By default, the address bar shows your current location, and whether it is a folder or a Web page. You can browse to another location by typing an address—a URL, a path, or even a program name. If you start typing a previously typed address, the AutoComplete feature finishes the address for you.
Standard buttons	Displays buttons for commonly used commands, such as copying, pasting, deleting items, changing views, and browsing backward and forward.

<i>Toolbar element</i>	<i>Description</i>
Quick Launch	Opens your browser or email program or allows you to view channels or instantly bring your desktop to the front. To add a new toolbar button, drag the program icon to the Quick Launch tray.

Displaying a toolbar in a window

- 1 On the desktop, double-click **My Computer**.
The My Computer window appears.
- 2 On the **View** menu, point to **Toolbars**, then click the name of the toolbar you want to display.
The toolbar appears below the menu bar of the current window.

Displaying information about each folder

In addition to displaying the contents of each window, you might find it helpful to have the operating system display the name of the folder and brief information about how to use the folder. In Windows[®] Millennium Edition terminology, this means displaying an individual window “as a Web page.”

- 1 Double-click **My Computer**.
The My Computer window opens.
- 2 Open the folder you want to view as a Web page.
- 3 On the **Tools** menu, select **Folder Options**.
- 4 Make the selections in Web View.
- 5 Click **Enable Web Content in Folders**.
- 6 Click **OK**.

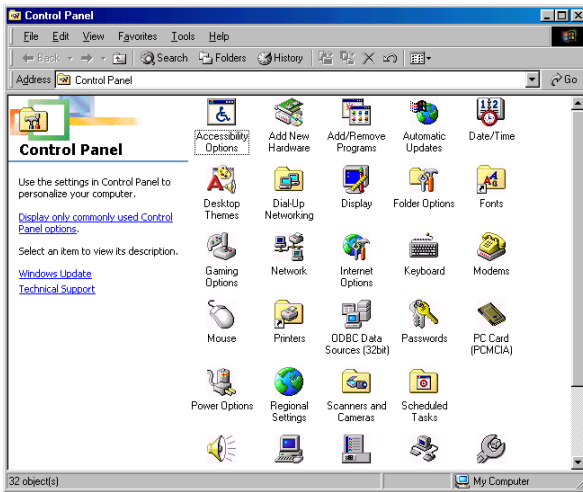

Sample Control Panel window as a Web page

The addition of the name of the folder and instructions for how to use the folder on the left give the window the appearance of a Web page.

Connecting a monitor, keyboard and mouse

By connecting an external monitor, external full-size keyboard and a mouse, you can work with your notebook as if it were a standard office desktop computer.



You can connect an external monitor to the monitor port. For more information, see “[Back](#)” on page 29.



You can connect an external USB-compatible keyboard and a USB-compatible mouse to one of the three USB ports. For more information about connecting a mouse, see “[Connecting a mouse](#)” on page 50.

Using the programmable buttons

Your computer has two programmable buttons on the indicator panel. They are the AP button and the Internet button.

- ❖ Pressing the AP button will bring up the Ez Button application.
- ❖ Pressing the Internet button will open Microsoft® Internet Explorer.



To program these buttons for other options, use the Ez Button application.

Click the **Ez Button** icon on the taskbar.

The Configure Buttons dialog box appears.

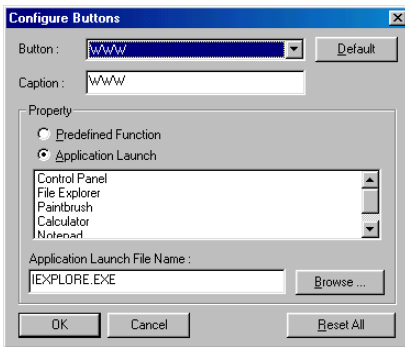

Sample Configure Buttons dialog box

Select one of the two buttons, WWW (Internet) or User (AP), from the Button drop-down list.

In the properties section, choose Predefined Function or Application Launch.

The predefined functions are:

- ❖ Close Application

Selecting Close Application closes any open window that you select.

❖ Mute

Selecting Mute will mute the sound system.

❖ Task Switch

Selecting Task Switch toggles between open applications.

Selecting the Application Launch will display a list of applications to choose from. You may select any of the application options to assign to your buttons, or you may select your own by using the Browse button.

By pressing the Reset All button, you will set the assigned buttons back to their default setting.

❖ The default setting for the AP Button is the Ez Button Application.

❖ The default setting for the Internet Button is Microsoft® Internet Explorer.

Using the Ethernet LAN Port

You can connect your computer to a Local Area Network (LAN) at work or from a remote location.

When your computer starts, the Windows® operating system attempts to contact a Dynamic Host Configuration Protocol (DHCP) server. If the computer is not connected to a network, it may pause a few minutes as it waits for a reply. To avoid this delay, you can configure the Windows® operating system to disable the LAN port.

To disable the LAN port:

- 1 Click **Start**, point to **Settings**, and click **Control Panel**.
- 2 Double-click the System icon and select **Device Manager**.
- 3 Select **Intel® Pro/100 VE Network Connection in Network Adapters**.

- 4 Click the **Properties** button.
- 5 Check the **Disable in this hardware profile** check box.
- 6 Click **OK**.

Your LAN port is now disabled.

Accessing a LAN

To access a LAN:

- ❖ At the office, you can connect the network Ethernet cable to the RJ45 jack on your computer.
- ❖ Your computer is also equipped for wireless communications. For more information, see [“Exchanging data with another computer” on page 144](#).
- ❖ From home or while on the road you’ll need a dial-up connection. Ask your network administrator for the telephone number to access the network.

Setting up a direct connection

To set up an office connection, consult your network administrator for network settings and additional considerations.

Using a wireless connection



Your system may come with an integrated Wi-Fi module. The following information is only for systems with Wi-Fi.

Do not remove the module from your computer. For assistance, contact a Toshiba Wireless Authorized Service Partner.

When using your Wi-Fi Mini PCI module, your computer may display a PC Card icon in the desktop’s system tray to indicate that it is in use. Do not confuse the system tray’s icon with other removable PC Card devices you may have installed.

You *can* use the system tray's PC Card icon to turn off your Wi-Fi Mini PCI module. However, you will need to restart your computer to turn it back on.

Setting up a dial-up connection

To set up a dial-up connection, use the Dial-Up Networking Wizard:

- 1 Click **Start** and point to **Programs**.
- 2 Point to **Accessories**, then to **Communications**, and click **Dial-Up Networking**.
- 3 Click **Make New Connection** and follow the directions on the screen.
- 4 Enter the phone number of your network connection and let the program dial the number.

The computer connects to the network.

Exchanging data with another computer

To transfer a large amount of information between computers, you need a wireless or physical connection and a synchronization program.

You can use the Windows® Millennium Edition Briefcase, the computer's Infrared port, or a specialized synchronization program that transfers data using a cable connected to the computers' parallel ports.

Transferring files using a parallel port connection

To transfer files using the computers' parallel ports, you need a LapLink®- compatible parallel cable.

Getting started

- 1 Connect the cable.
- 2 Load the transfer program on both computers.
- 3 Set any specific options.
- 4 Start the transfer.
- 5 When you have finished transferring files, close the programs on both computers.

Getting help

- 1 Click **Start**, then **Help**.
- 2 Choose the **Index** tab.
- 3 In the dialog box, type direct cable connection.
- 4 Follow the online guide instructions.

Transferring files using the Infrared port

You can transfer files to another computer using your Satellite Pro notebook computer's Infrared port. Both computers involved in the data transfer must have compatible Infrared ports and synchronization software.

Connecting to the Internet

To connect to the Internet you need:

- ❖ A modem (one comes with your Satellite Pro computer)
- ❖ A telephone line, DSL or cable connection
- ❖ A browser or communications program
- ❖ An Internet Service Provider (ISP)

Making the physical connection

You can connect to the Internet by using a telephone and modem or through other higher-speed communication methods, such as Digital Subscriber Lines (DSL), cable, and satellite link.

Using a modem

If you're using a modem, you connect the modem to one of the computer's COM (communications) ports. The default setting for the modem is COM3.

If you are having trouble connecting through the modem, you may need to determine the current COM port name and possibly change it.

Determining the COM Port

To find out which port your modem is connected to:

1 Click **Start**, point to **Settings**, and click **Control Panel**.

2 Double-click **Modems**.

The operating system displays the Modem Properties dialog box.

3 Click the **Diagnostics** tab.

Your modem should be listed next to one of the computer's COM ports.

4 Make a note of the COM port number.

5 To verify that the modem is set up properly, click the port to which your modem is connected, and then click **More Info** to run the Windows Millennium Edition Modem Diagnostics.

The operating system communicates with the modem and displays identifying information reported by the modem. If the operating system cannot communicate with the modem, it displays an error message. Consult the troubleshooting

sections of your modem and Windows® Millennium Edition documentation.

- 6 Click **OK** to close the Modem Properties dialog box.
- 7 Close the Control Panel.

Signing up with an Internet Service Provider

An Internet Service Provider (ISP) is a company that has the equipment and the telecommunication lines necessary to maintain an Internet connection.



Microsoft's Web browser, Internet Explorer, which is preinstalled on your system, is automatically configured so that when you first start it, it guides you through signing up for a new ISP account, or assists you in setting up your computer to work with your existing ISP.

Once you have established an ISP account, you can access the Internet.

Getting started

- 1 Connect your computer's modem to a telephone line.



TECHNICAL NOTE: If you are using the telephone line at home, disable Call Waiting before you connect through the modem. Call Waiting interrupts data transmission.



- 2 Start your Web browser. Have your modem dial the ISP's telephone number, and establish a connection with the ISP's computer.

If you are using your computer at the office, then you probably connect to the Internet through your company's local area network. For more information, see ["Using the Ethernet LAN Port"](#) on page 142.

Using the Internet

The following sections give a quick introduction to the Internet and some of its exciting features, under these headings:

- ❖ The Internet
- ❖ The World Wide Web
- ❖ Surfing the Internet
- ❖ Internet features
- ❖ Uploading and downloading files from the Internet

For more information about the Internet, see [“Lesson 3: Learning about the Internet”](#) on page 106.

The Internet

The Internet is an association of thousands of networks and millions of computers around the world connected by communications lines. They all work together to share information.

The World Wide Web

The World Wide Web (or ‘Web’) is a subset of the Internet—a collection of interlinked documents (located on computers connected to the Internet) that work together using a specific Internet protocol called Hypertext Transfer Protocol (HTTP).

The World Wide Web offers information as text, images, audio, or video to be referenced from anywhere in the world. Special programs called Web browsers are specifically designed to work with HTTP. They make it easier to connect to a particular network address and send and receive information.

Surfing the Internet

Once connected to the Internet, the Web browser displays a home page, for example, your ISP's home page on the Internet or your company's Web site home page.

To visit a desired Web site, type in the Web address. The Web address, or Uniform Resource Locator (URL), is a unique identifier for that computer system linked to the Internet. Web addresses can also appear within a Web page's text, and are known as links. Clicking a link automatically transfers your Web browser to that site.

You can also use a Search Engine, a Web site specifically designed to help you look for information.

Internet features

The Internet offers many types of communication tools to help you perform many tasks.

❖ Internet email

To send and receive email of your own, you need a mailbox on the Web, or an email address.

If you have an account with an ISP, you can probably set up an email address at the same time as you sign up for the service.

❖ Internet chat rooms

A chat room is a Web site that offers a place where people with similar interests and ideas can communicate in real-time, one-on-one or in groups, by typing messages which are instantly viewed by others on their computer screens.

❖ Internet news groups

A news group is similar to a chat room, but instead of using a dedicated site to converse about a specialized subject with

others in real-time, it uses a Web site as a clearinghouse where all the messages are placed, like a gigantic bulletin board.

❖ **Online shopping**

Many Web sites offer products and services for sale.

Uploading and downloading files from the Internet

Transferring files from one computer to another is termed uploading (transferring data from your computer to a site on the Web), or downloading (transferring data from a site on the Web to your computer).

There are several ways to upload or download data. It can be as simple as attaching a file or document to an email, or you can use the File Transfer Protocol (FTP) features of your Web browser to transfer large amounts of data.

Toshiba's online resources

Toshiba maintains a number of online sites to which you can connect. These sites provide information about Toshiba products, give help with technical questions, and keep you up to date with future upgrades. For more information, see [“Contacting Toshiba”](#) on page 221.

Conducting an electronic meeting

The SPANworks™ 2000 application offers enhanced meeting productivity between networked computers. You can do such things as transfer files between two computers, broadcast a slide presentation simultaneously to several machines, set up electronic

business cards, and send text messages to a few people or to everyone in your proximity.



NOTE: Before using SPANworks 2000, you must establish a network link between computers.

To access SPANworks 2000:



- 1 Double-click the **SPANworks** icon on the desktop.
- 2 Follow the instructions on your screen to set up a connection to the network.

SPANworks 2000 file utilities

The central application of SPANworks 2000 is designed to enable data transfers among a group of computers with or without using wired connections. You can transfer files, browse authorized locations on other computers, or synchronize data with other computers. A record of each transaction is maintained in a list or archive so you know exactly what you sent to others, or received from them.



TECHNICAL NOTE: Toshiba recommends that you start the SPANworks 2000 application after closing all other applications. This will ensure system resources are available since in the presentation function, SPANworks 2000 may stop opening a presentation if the amount of remaining system resources is less than required.

Sending a fax

To send a fax, your system must be connected to a telephone line.

Faxing a document is almost as simple as printing it.

- 1 On the desktop, double-click the **RingCentral** icon.
If the icon is not on the desktop, click **Start**, then **Programs**. Go to the RingCentral® folder and click **RingCentral**.
The RingCentral Setup Wizard appears.
- 2 Select **Next** and follow the instructions on the screen.

Exploring video features

Your computer's video features include:

- ❖ Viewing Windows® presentations or DVD movies either on the computer screen (display panel or external monitor) or on a television set.
- ❖ Capturing video using a camera connected to the i.LINK port.
- ❖ Playing back VideoCDs.

Viewing presentations or DVD movies on your television

To use your television for this purpose, you need to connect your television to your computer via the S-video out port, change the display setting on your computer, and direct the computer's video output to your television.

Connecting a television to the S-video out port

To view a DVD movie or Windows® presentation in full-screen mode on your TV you need to use the S-video out port.

To connect a device to the S-video out port, you'll need an S-video cable (not included with your system). For the best video quality, always use a properly shielded cable.



NOTE: Before connecting the device, make sure that it is ready to receive S-video input. Some devices have a switch or button that changes this setting. Others may provide a menu-driven option from a remote control. Refer to the documentation provided with your device to see if any set up is necessary.



TECHNICAL NOTE: Using an S-video cable of poor quality may result in dull or fuzzy picture, poor color, ghosting, video noise, or loss of video.



HINT: It is recommended that you use an S-video cable no longer than 20 feet, approximately 6 meters.

To connect the television:

- 1** Connect one end of the S-video cable to the external television.
Refer to the documentation provided with the device for the location of the video in port.
- 2** Connect the other end of the cable to the S-video out port on the back of your computer.
To locate the port, see [“Back” on page 29](#).
- 3** Turn on the television.

Changing the display properties setting

- 1 Right-click anywhere on your desktop and select **Properties**.

The Display Properties dialog box appears.

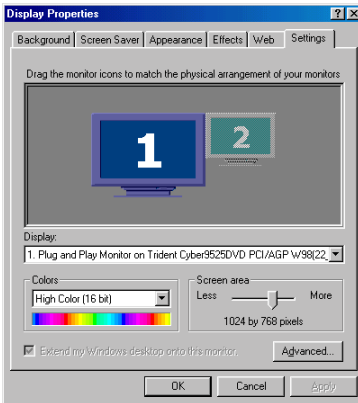

Sample Display Properties dialog box

- 2 Click the **Settings** tab.
- 3 Slide the Screen area slider bar toward **Less** until the setting reads **640 x 480**.
- 4 Click **Apply**, then **OK**.

Direct video output to television

- 1 Click **Advance** button.
- 2 Select **Twin view** tab.
- 3 Click **Output device** button.
- 4 Choose **Select output device**.
- 5 Click on **TV** option.
- 6 In Format, select **NTSC-n**.
- 7 Click **Apply**.

- 8 Click **OK**.
- 9 Open the DVD tray and insert DVD title.
The DVD movie should play automatically.

Transferring and editing video data

The i.LINK port on the right side of the computer provides very fast data transfer rates (up to 400 Mbps or 400 million bits per second). You can connect up to 63 external devices to this port. Each peripheral device receives power from the computer through the i.LINK port.

In addition to its high speed, it supports isochronous data—the delivery of data at a guaranteed rate. This makes it ideal for devices that transfer high levels of data in real-time, such as video devices.

Like your USB ports, the i.LINK port supports both Plug-and-Play (automatic configuration) and hot swapping (the ability to connect and disconnect devices while the computer is on). The main difference between the i.LINK port and your USB ports is that the i.LINK port supports faster data transfer rates.

Playing VideoCDs



TECHNICAL NOTE: VideoCD playback capability is not enabled on all systems.

- 1 Fit the DVD-ROM drive in the Modular Bay, if necessary.
- 2 Place the VideoCD in the DVD-ROM drive.
- 3 Launch WinDVD 2000 and press the **Play** button.

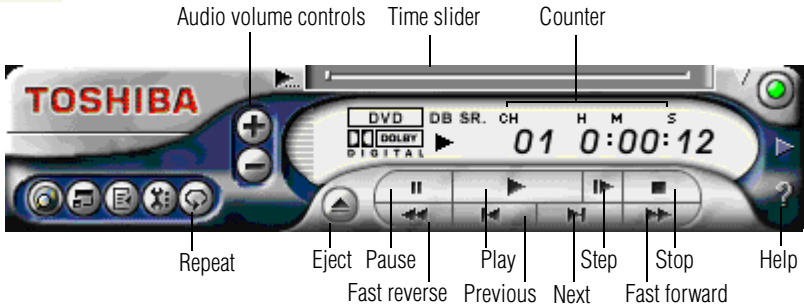

Sample WinDVD control panel with playback controls called out



HINT: There are no menus for VideoCD 1.0 titles.

For more information about using WinDVD 2000, see [“WinDVD 2000”](#) on page 163.

Exploring audio features

You can use your computer to record sounds using an external microphone. You can play .wav sound files or audio CDs using the built-in speakers, headphones or external speakers.

Recording sounds

You can make audio recordings and save them as .wav files by connecting an external microphone or other sound source to the

microphone jack and using the Sound Recorder feature in the operating system.



DEFINITION: A .wav (pronounced “wave”) file is the Windows® format for storing sound in files in the operating system.

Using a microphone



- 1 Connect an external microphone to the computer.
To locate the microphone port, see “Left side” on page 31.
- 2 Click **Start**, point to **Programs, Accessories, Entertainment**, then click **Sound Recorder**.

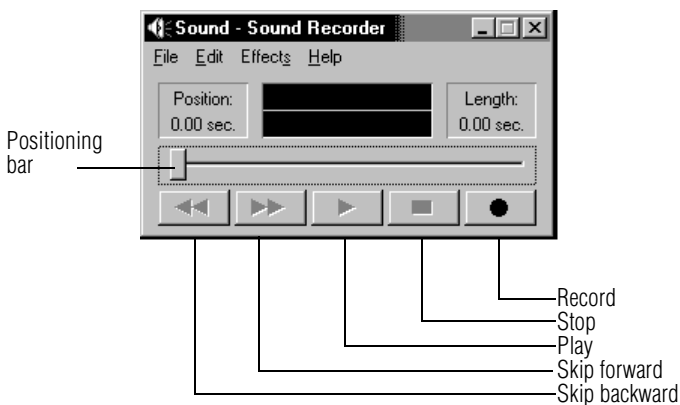

Sample Sound Recorder screen



- 3 Click the **Record** button and speak normally into the microphone.

The maximum recording time is 60 seconds.



- 4 When you have finished recording, click the **Stop** button.



- 5 To hear what you just recorded, click the **Play** button.

- 6 To save the file, select **Save** from the **File** menu.

Adjusting recording quality

The better the quality of the recording, the more disk space the sound file requires. Experiment to find a balance that fits your needs.

- 1 Open Sound Recorder, if necessary (click **Start**, point to **Programs, Accessories, Entertainment**, then click **Sound Recorder**).
- 2 In the Sound Recorder window, click **Edit**, then click **Audio Properties**.
- 3 In the Audio Properties dialog box, adjust the Sound Recording, Preferred device, and Advanced quality.
- 4 Click **OK**.

Your new settings take effect the next time you record.

Using external speakers or headphones

Your computer is equipped with a full stereo sound system with internal speakers. Instead of using the internal speakers, you can connect headphones or a pair of external stereo speakers.



TECHNICAL NOTE: Use amplified speakers that require an external power source. Other types of speakers will be inadequate to produce sound from the computer.

To play back sound files through external speakers or headphones:



- 1 Locate the headphone jack on the computer.
To locate the headphone jack, see [“Left side” on page 31](#).
- 2 Using any necessary adapters, plug the cable from the headphones or external speakers into the headphone jack.
The headphone jack requires a 16-ohm stereo mini-jack.

3 Adjust the volume:

- ❖ For external speakers, use the volume controls on each speaker.
- ❖ For headphones, use the computer's volume control dial.

Using PC Cards

PC Cards expand your computer's capabilities and usefulness. You can purchase additional PC Cards from your dealer. Most PC Cards conform to the PCMCIA (Personal Computer Memory Card International Association) standard.

Your computer has two stacked PC Card slots and supports three types of PC Cards:

- ❖ Two Type I and Type II cards.
- ❖ One Type III card.

Check the documentation that came with the PC Card to see if it conforms to the PCMCIA 2.1 standard, or later. Other cards may work with your computer, but are likely to be much more difficult to set up and use.

PC Card supporting software

PC Cards require Card and Socket Services software — a set of programs that acts as a translator between the PC Card and the computer, and that makes hot swapping (switching cards while the computer is on) possible.

The Windows[®] Millennium Edition operating system provides the Card and Socket Services for your PC Card. Even if your PC Card comes with its own version of Card and Socket Services, you should use the files included in the Windows[®] Millennium Edition operating system.

Inserting PC Cards

- 1 If your PC Card does not support hot swapping, save your data and turn off the computer before inserting the PC Card. For more information, see [“Hot swapping” on page 161](#).
- 2 Hold the PC Card with the arrow side up and the connector side toward the slot.
- 3 Align the card connectors with an available PC Card slot and carefully slide the card into the slot until it locks into place.



NOTE: If you have a Type III card, insert the connector into the lower slot. If you have a Type I or Type II card, you can insert it into either the upper or the lower slot.

There are two eject buttons, one per slot.



CAUTION: To avoid damaging the PC Card or the computer, don't force the card into the PC Card slot.

Removing PC Cards

- 1 Click the **PC Card** button on the taskbar.
- 2 Click **Stop xxxx** where xxxx is the identifier for your PC Card.
The operating system advises you that you may safely remove the card.
- 3 To remove the PC Card, press the slot's eject button once.
- 4 Remove the PC Card and store it properly.

Hot swapping

One of the great things about PC Cards is that you can replace one PC Card with another while the computer is on. This is called “hot swapping.”

Hot swapping precautions

Although you can insert a PC Card at any time, to avoid data loss never remove a card while it is in use. For example:

- ❖ Never remove a hard disk card while the system is accessing it.
- ❖ Never remove a network card while you are connected to a network.

Before removing a PC Card, shut it down by clicking the PC Card (PCMCIA) icon on the taskbar. Once the PC Card has stopped, you can safely remove it. See [“Removing PC Cards” on page 160](#).

Using SmartMedia cards

SmartMedia cards are super compact memory cards that are highly portable and can be carried in a pocketbook or credit card holder. SmartMedia cards are used to exchange data with other portable devices, such as digital cameras and Personal Digital Assistants (PDAs). They are also found in electronic musical instruments, voice recorders, faxes, printers, scanners, word processors and handy terminals.

To locate the SmartMedia card slot, see [“Left side” on page 31](#).

Inserting a SmartMedia card

- 1 Turn the card so that the connector (metal area) faces up.
- 2 Push the card into the slot until it locks in place.

Removing a SmartMedia card

- 1 Press the card inward to release it.
The card pops out slightly.
- 2 Lift the side of the computer, grasp the card, and pull it straight out.

Emulating a full-size keyboard

Although the computer's keyboard layout is compatible with a standard full-size keyboard, it has fewer keys.

Pressing the Fn key simultaneously in combination with one of the specially marked keys allows you to emulate a full-size keyboard.

Chapter 7

WinDVD 2000

WinDVD is a software program for playing back CDs, VideoCDs and DVDs. This chapter explains how to use this program.

Playing DVDs



TECHNICAL NOTE: For optimum DVD performance, always play DVDs while your computer is connected to AC power.

For systems with a DVD-ROM or DVD-ROM/CD-RW multifunction drive, you can use InterVideo WinDVD™ to play DVDs. WinDVD is an easy-to-use, full-featured multimedia control center that helps you get the most out of the exciting world of DVD technology. If your computer has a DVD-ROM or

DVD-ROM/CD-RW multifunction drive, your computer comes with WinDVD preinstalled.



WARNING: Before playing a DVD, turn down the volume. Playing the disc at maximum volume could damage your ears. See “Using the control panel playback buttons” on page 167 to locate the volume control buttons.

Fit the DVD-ROM or DVD-ROM/CD-RW drive into the Modular Bay. Insert a DVD into the drive, following the instructions in “Inserting a disc” on page 77. The computer automatically detects the disc in the drive and opens WinDVD. If the autoplay feature is enabled, the DVD automatically begins to play (see “Setting general properties” on page 173 for information on enabling autoplay).

To open WinDVD manually:

- 1 Click **Start**, and point to **Programs**.
- 2 Point to **InterVideo WinDVD**, then click **InterVideo WinDVD**.



Time slider
Playback speed slider
Current time slot indicator
Current chapter indicator

Sample WinDVD video window with the control panel

Using the WinDVD toolbar

The WinDVD window contains a toolbar at the top and a status bar at the bottom. If the toolbar or status bar does not appear, you can display them by following the instructions in [“Setting general properties”](#) on page 173.

The toolbar contains basic DVD playback controls. Pause the pointer over a button to display its definition. The toolbar also contains an adjustment button (see [“Adjusting the color balance”](#) on page 183 for more information).

Using the WinDVD status bar

The time slider enables you to rapidly move forward or backward in the DVD content. Move the time slider to the left to go

backward or move it to the right to go forward. The current time slot is indicated on the right side of the status bar.

The playback speed slider enables you to control the speed at which the DVD plays. Move the slider to the left to slow the playback speed or move it to the right to play the DVD faster. Placing the slider in the center plays the DVD at normal speed, and enables the audio. The audio is automatically muted at any other playback speed.

The current chapter indicator displays the DVD chapter that is currently playing.

Using the WinDVD control panel

The WinDVD control panel resembles the control panel of a standard home DVD player.



TECHNICAL NOTE: The DVD author determines what features the DVD supports. Depending on the DVD format and your computer's hardware configuration, some of the control panel features may be unavailable when playing a DVD. Unsupported features appear gray, and you cannot select them.

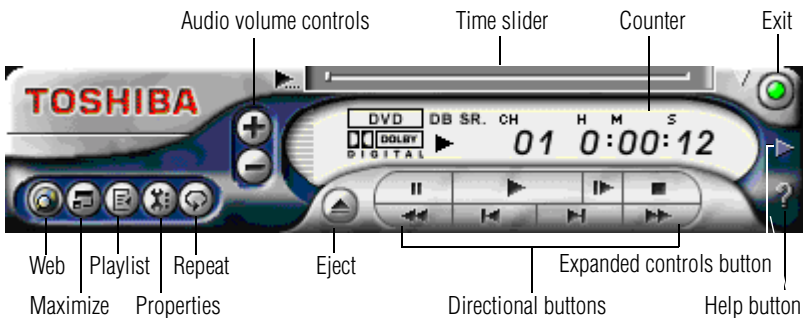

Sample WinDVD control panel

You can open a shortcut menu, by positioning the cursor over the WinDVD window, other than over the control panel, then clicking the secondary button. The shortcut menu contains the same features as the control panel, plus the enable caption feature, which displays captions for the hearing impaired.

You can also create a playlist, to customize the order in which the DVD content plays (see [“Creating playlists” on page 170](#)). Once a DVD is playing, the counter displays the current chapter and elapsed time, in *hours:minutes:seconds* format.





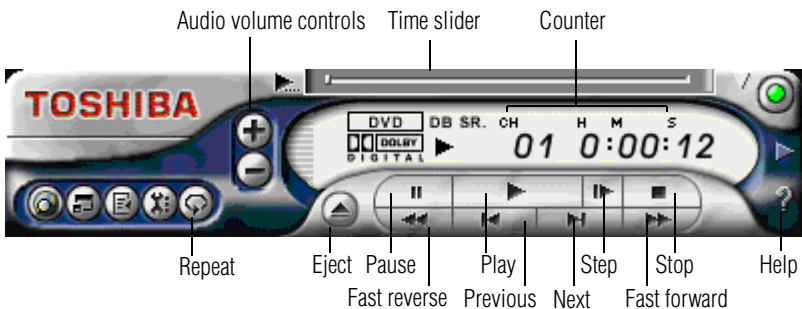

From the WinDVD control panel, you can open an expanded control panel by clicking the expanded controls button. The expanded control panel contains several advanced features. See [“Using WinDVD Advanced Features” on page 177](#) for an explanation of these features.







Using the control panel playback buttons

Once you have inserted a DVD and started WinDVD, you are ready to play the disc. Using the control panel, you can play a DVD from the beginning, or move to a desired location then begin playing.



Sample WinDVD control panel

<i>Click this</i>	<i>To do this</i>	<i>Or use keyboard shortcut</i>
	Repeat — repeat the current chapter, if the DVD contains chapters. Otherwise this button repeats the DVD from the beginning. When the repeat button is activated, the repeat symbol appears to the left of the chapter number on the control panel counter. The DVD continues to repeat until you click the repeat button again, and the repeat symbol no longer displays on the control panel.	None
	Eject — open the DVD-ROM drive disc tray.	E
	Pause — temporarily stop playing a DVD.	Spacebar
	Play — start playing a DVD.	Spacebar
	Step — move forward through the DVD one frame at a time. Each time you click this button the DVD moves forward one frame.	None
	Stop — cease playing a DVD. After stopping the DVD, click the play button to resume playing the DVD.	End

<i>Click this</i>	<i>To do this</i>	<i>Or use keyboard shortcut</i>
	Fast reverse — move quickly backward through the DVD content. When you reach the desired location, click the play button to resume playing the DVD.	R
	Previous — move to the beginning of the previous chapter and resume playing the DVD.	PgUp
	Next — move to the next chapter and resume playing the DVD.	PgDn
	Fast forward — move quickly forward through the DVD content. When you reach the desired location, click the play button to resume playing the DVD.	F
	Time — move to a specific time slot, then click the play button to play the DVD from the selected location.	None
	Audio volume controls — click the plus button to increase volume. Click the minus button to decrease volume.	Shift ↑ (increases) Shift ↓ (decreases)

Maximizing the video window



To close the WinDVD control panel and expand the video window to fill the screen, click the Maximize button.

To display the control panel again, double-click anywhere in the video window.

Using playlists



TECHNICAL NOTE: The DVD author determines what features the DVD supports. Depending on the DVD format and your computer's hardware configuration, some of the control panel features may be unavailable when playing a DVD. Unsupported features appear gray, and you cannot select them.

A playlist is a customized list of DVD files in the order in which you want to view them. For example, you may want to create a playlist for DVDs that contain music files, so you can play the music selections you want in the order you want to hear them. You can only save one playlist at a time.

Creating playlists



- 1 On the WinDVD control panel, click the playlist button.
The Playlist window appears.

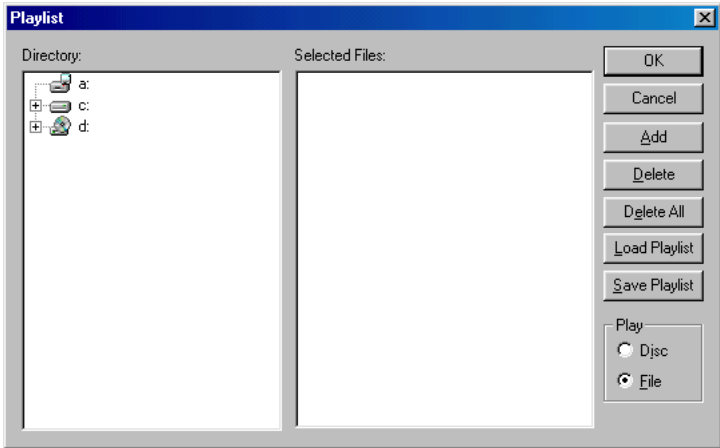

Sample Playlist window

- 2 Click the **File** button in the lower-right corner of the window, to indicate that you are creating a playlist of individual files.
- 3 In the **Directory** list, select the file you want to play first, and click **Add** to put it at the top of the playlist.

DVD files have an .mpg, .vob or .ac3 file name extension. After selecting a file, the file name appears in the **Selected files** list. You can also double-click a file name to add it to the playlist.

- 4 Add as many files as you wish to the playlist. You must add the files in the order in which you want to play them.

To delete a file from the playlist, select the file in the **Selected files** list, then click **Delete**. To delete the entire list and start over, click **Delete All**.

- 5 When you have finished creating your playlist, click **Save Playlist** to save it.

You do not assign a name to the saved playlist, as you can only save one playlist at a time. After saving the playlist, a confirmation dialog box appears.

- 6 Click **OK** to close the confirmation dialog box, then click **OK** to close the **Playlist** window.

Loading and playing playlists

- 1 In the Playlist window, click **File** to display the saved playlist of files.
- 2 Click **Load Playlist** to load the saved playlist.
After loading the playlist, a confirmation dialog box appears.
- 3 Click **OK** to close the confirmation dialog box, then click **OK** to close the **Playlist** window.

The DVD begins to play the loaded playlist.

Resuming normal playback after using playlists

To resume playing the DVD files in order after using a playlist, click the eject button to open the disc tray, then close it again. The DVD resumes normal playback.

Customizing WinDVD

You can control several general WinDVD characteristics, such as whether the toolbar and status bar are visible, as well as numerous audio and display features.

You control these general, audio and display features from the Properties dialog box.

- 1 Launch WinDVD, if it is not already running.
- 2 On the WinDVD control panel, click the **Properties** button.

WinDVD displays the **Properties** dialog box, with the **General** tab on top.

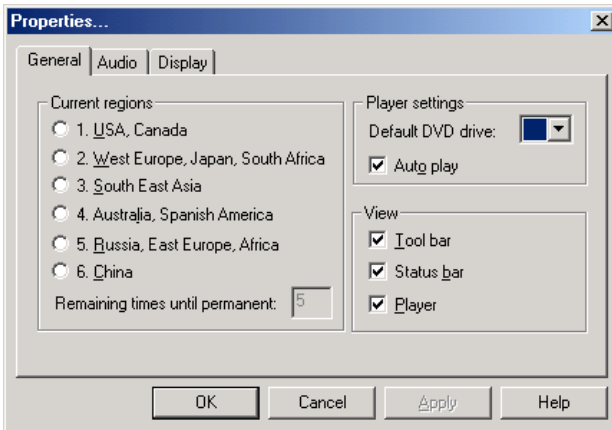

Sample Properties dialog box with the General tab on top

Setting general properties

You use the **General** tab to select the region code, the drive letter assigned to the DVD-ROM drive, the autoplay default option, and which WinDVD toolbars are displayed by default.

Region coding is part of the protection system for DVD content. It divides the world into six regions. The intent is to enable specific content to be viewed in a specific region. The current region code of the WinDVD player installed in your computer is Region 1, comprising the United States and Canada.



*NOTE: Most DVD-ROM drives let you change the region code, usually between one and five times. Once a drive has reached the limit, the region code cannot be changed again. Pay careful attention to the **Remaining times until permanent** box on the General properties tab.*

- 1 To change the region code, select the desired option in the **Current regions** list.

The **Remaining times until permanent** box displays the remaining number of times you can change the current region before the setting becomes permanent.

- 2 In the **Player settings Default DVD drive** box, select your DVD-ROM drive letter.
- 3 Select the **Player settings Auto play** check box to enable the auto play feature. Clear the check box to disable this feature.

When enabled, the auto play feature automatically launches a DVD-ROM when it is inserted in the DVD-ROM drive.

- 4 In the **View** box, select the items you want to display when WinDVD launches.

Tool bar is the bar containing basic player functions that is displayed at the top of the WinDVD video window.

Status bar is the bar that is displayed at the bottom of the WinDVD video window.

Player is the WinDVD control panel.

- 5 Click **OK** to save your settings.

Setting audio properties



NOTE: The DVD author determines which features the DVD supports. When playing a DVD, some of the control panel features may be unavailable. Unsupported features appear gray, and you cannot select them.

- 1 In the Properties dialog box, click the **Audio** tab.

The Audio tab moves to the front. The **Current audio track** box displays the current audio format and attributes.

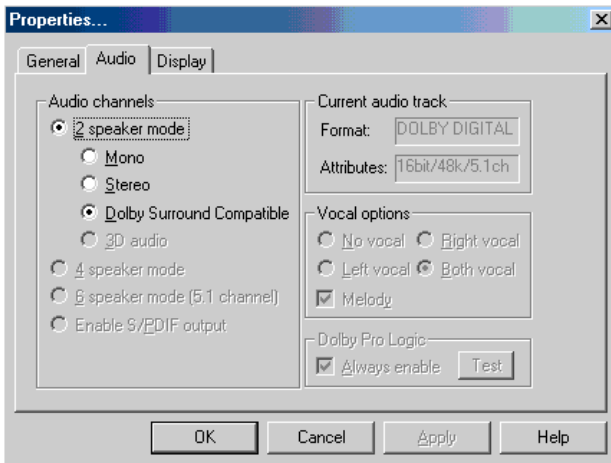

Sample Properties dialog box with Audio tab on top.

- 2 In the **Audio channels** box, select the appropriate speaker mode to match your setup as follows:
 - ❖ If you have two speakers, select one of the **2 speaker modes**. **Mono** mixes the audio channels into one channel. **Stereo** mixes the audio channels into two channels. **Dolby Surround Compatible** mixes the audio channels into two channels plus Dolby Pro Logic Surround sound. **3D audio** provides standard 3D audio sound.
 - ❖ If you have four speakers, select **4 speaker mode**. WinDVD distributes four unique sound channels to the speakers, providing a true surround sound experience.
 - ❖ If you have six speakers, select **6 speaker mode**. WinDVD automatically distributes 5.1 sound channels to these speakers, for enhanced surround sound.
 - ❖ If you have an S/PDIF compliant sound card, select **Enable S/PDIF output**. This option sends the stereo output through the sound card to an external receiver.

- 3 In the **Vocal options** box, select the desired option for DVDs that support vocal as follows:
 - ❖ **No vocal** does not output vocals to any speaker.
 - ❖ **Left vocal** outputs vocals to left speakers only.
 - ❖ **Right vocal** outputs vocals to right speakers only.
 - ❖ **Both** outputs vocals to both left and right speakers.
- 4 In the **Dolby Pro Logic** box, select the **Always enable** check box to enable Dolby Pro Logic. Clear the check box to disable it.
- 5 To test Dolby Pro Logic, click the **Test** button.

Setting display properties

- 1 In the Properties dialog box, click the **Display** tab.
The **Display** tab moves to the front.

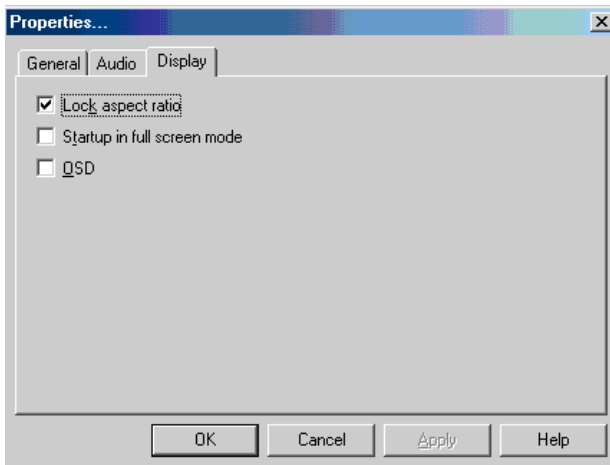

Sample Properties dialog box with Display tab selected

- 2 Select the **Lock aspect ratio** check box to maintain the original aspect ratio when the video window is resized. Otherwise clear the check box.
- 3 Select the **Startup in full screen mode** check box to automatically start WinDVD each time with the video window maximized and the control panel hidden. Otherwise, clear the check box.
- 4 Select the **OSD (On Screen Display)** check box to enable OSD. Otherwise, clear the check box.
- 5 Click **OK** to save the settings.

Customizing the control panel

You can configure the control panel's appearance. Position the pointer over the control panel, then click the secondary button to display a shortcut menu of control panel options. You can select a new control panel background color, or select **WinDVD** to display the control panel in a different format. You can also select **About** to display copyright and version information.

Using WinDVD Advanced Features



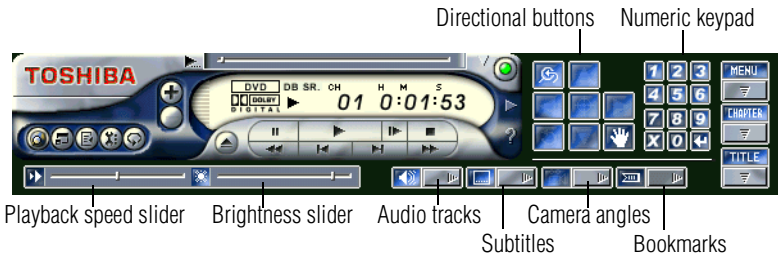

TECHNICAL NOTE: The DVD author determines what features the DVD supports. Depending on the DVD format and your computer's hardware configuration, some of the control panel features may be unavailable when playing a DVD. Unsupported features appear gray, and you cannot select them.

The features described in this section are available on the WinDVD expanded control panel. To open the expanded control panel, click the expanded controls button on the WinDVD main control panel. See [“Playing DVDs” on page 163](#) for help locating the expanded controls button.



WinDVD expanded control panel

<i>Use this</i>	<i>To do this</i>	<i>Or use keyboard shortcut</i>
	<p>Playback speed— control the speed at which the DVD plays. Move the slider to the left to slow the playback speed or move it to the right to play the DVD faster. Placing the slider in the center plays the DVD at normal speed, and enables the audio. The audio is automatically muted at any other playback speed.</p>	None
	<p>Brightness — move the slider to the right to increase video brightness. Move it to the left to decrease brightness.</p>	<p>+ (increases) - (decreases)</p>

Use this



To do this

Directional buttons — use to navigate the WinDVD menus, as you would the arrow keys on the keyboard. The center button represents Enter.

Or use keyboard shortcut

↑ (Up)
→ (Right)
↓ (Down)
← (Left)
Enter





Numeric keypad — use these buttons to select a chapter by entering the chapter number. After you have entered a chapter number, click the enter button on the lower right corner of the numeric keypad (↵) to begin playing that chapter. You can clear an entry by clicking the clear (X) button on the lower left corner of the numeric keypad.



0 - 9



Menu button — displays all available menus for the current DVD. Examples of menus are: Root, Audio Language, Subtitles. Use your mouse or the control panel directional buttons to select a menu. Click **Resume** to resume DVD playback.

None

<i>Use this</i>	<i>To do this</i>	<i>Or use keyboard shortcut</i>
	Chapter button — displays a list of all the chapters in the current DVD. Select the chapter you want to play, or use the numeric keypad to enter the chapter number.	C
	Title button — Displays a list of all the titles on the current DVD. Click the title you want to play, then click Enter .	T
	Audio tracks — displays a list of all the audio track options. This feature is most commonly used with multi-language content to change the spoken/heard language. This button is enabled only when the DVD supports dynamic audio track changes.	A

<i>Use this</i>	<i>To do this</i>	<i>Or use keyboard shortcut</i>
	<p>Subtitles — displays a list of all the available language subtitles. This button is enabled only for DVD content that includes subtitles and supports dynamic subtitle information changes. Select the desired language, or select Default to display subtitles in the DVD's default language.</p>	S
	<p>Camera angles — display a list of all the available camera angles. Due to differences in the DVD mastering process, some multi-angle views may not function properly.</p>	G

<i>Use this</i>	<i>To do this</i>	<i>Or use keyboard shortcut</i>
	<p>Bookmark — save an unlimited number of locations on the DVD for quick reference. On the bookmark shortcut menu, click Add to open the Add Bookmark dialog box. Type a bookmark name, then click OK. The bookmark name appears on the bookmark shortcut menu. Click the bookmark name to go to that location on the DVD. Click Delete All to delete all bookmarks.</p>	None

Zooming in

You can zoom in on an area of the WinDVD video window to get a closer look.



- 1 Click the Zoom button, located in the upper-left corner of the directional button panel.
- 2 Position the cursor over the top-left corner of the area you want to view in close up.
- 3 Hold the primary button and drag the cursor to the bottom-right corner of the area you want to view in close up.

A dotted rectangle appears around the area you wish to view.

- 4 Release the primary button.

WinDVD automatically fills the window with the selected area.

Panning

Once you are zoomed in on an area of the WinDVD video window, you can move the zoom window location using the pan feature.



- 1 With the video window in zoom mode, click the pan button, located in the lower-right corner of the directional button panel.
- 2 With the pointer over the center of the window, drag the zoomed window up, down, left or right.

The close-up view changes to reflect the new zoom window location.

Zooming out



To return the video to normal size, click the zoom button. The video also returns to normal size when you reach the zoom limit.

Adjusting the color balance



You can adjust the DVD color balance. Click the adjustment button on the main DVD video window toolbar to open the Adjustment dialog box.

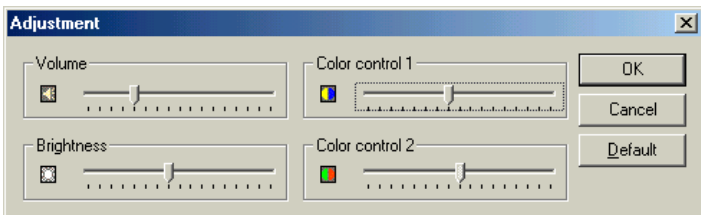

WinDVD Adjustment dialog box

The adjustment dialog box provides another set of sliders for adjusting volume and brightness. It also provides two color control sliders.

Move the **Color control 1** slider to the right to increase the blue and decrease the yellow color values. Move the slider to the left to increase the yellow and decrease the blue color values.

Move the **Color control 2** slider to the right to increase the red and decrease the green color values. Move the slider to the left to increase the green and decrease the red color values.

Launching an Internet browser from WinDVD



Some DVDs contain links to Web sites. To enable these links, click the control panel Web button to launch your Internet browser.

Getting Help



Click the control panel Help button to open the WinDVD Help system.

Exiting WinDVD



Click the control panel Exit button, or click the Close button, to exit WinDVD.

Chapter 8

If Something Goes Wrong

Some problems you may encounter when using your notebook computer are relatively easy to identify and solve. Others may require help from your dealer or the manufacturer of a software program.

This chapter aims to help you solve many problems by yourself. It covers the problems you are most likely to encounter. For further assistance and solutions, use Toshiba's support tool, VirtualTech, to help diagnose and solve possible problems.

If all else fails, contact Toshiba. You will find information on Toshiba's support services at the end of this chapter.

Problems that are easy to fix

Your program stops responding.

If you are working with a program that suddenly freezes all operations, chances are the program has stopped responding. You can exit the failed program without shutting down The Windows[®] Millennium Edition operating system or closing other programs.

To close a program that has stopped responding:

- 1 Press **Ctrl, Alt, and Del** simultaneously (once).

The operating system displays the **Close Program** dialog box. This box lists all the programs and processes currently in operation. If a program has stopped responding, the words “not responding” appear beside its name in the list.

- 2 Select the program you want to close, then click **End Task**.

Closing the failed program should allow you to continue working. If it does not, continue with step 3.

- 3 Close the remaining programs one by one by selecting the program name, then **End Task**.

- 4 Click **Shut Down**.

The computer shuts down.



*CAUTION: Pressing **Ctrl, Alt, and Del** simultaneously twice to restart your computer is not recommended. By closing all open programs before shutting down the system you ensure that all data is saved.*

Your program performs an illegal operation.

If you receive the message, “Your program has performed an illegal operation,” you should record the details of the message and consult the software manufacturer.

To record the details:

- 1 Click the **Details** button and select the text Windows Millennium Edition displays.

The **Details** button displays information that the software manufacturer needs to help you solve your problem.

- 2 Press **Ctrl and c** simultaneously to copy the text to the clipboard.

- 3 Open Notepad (click **Start**, point to **Programs**, then point to **Accessories** and click **Notepad**).
- 4 Press Ctrl and v simultaneously to paste the details into Notepad.
- 5 Add a paragraph break and type some notes describing what you were doing when you received the message.
- 6 Save the file and refer to it when you contact the software manufacturer.

Problems when you turn on the computer

These problems may occur when you turn on the power.

The computer will not start.

Make sure you attached the AC adapter and power cable properly or installed a charged battery.

Press and hold down the power button for a few seconds.

If you are using the AC adapter, check that the wall outlet is working by plugging in another device, such as a lamp.

The computer starts but, when you press a key on the keyboard or touch the AccuPoint II, nothing happens.

You are probably in Standby mode and have a software or resource conflict. When this happens, turning the power on returns you to the problem instead of restarting the system. To clear the condition, press Ctrl, Alt, and Del simultaneously, or press the reset button.

Clearing the condition may get the computer running, but it won't solve a resource conflict. Read the documentation that came with the conflicting device and [“Resolving a hardware conflict” on page 194.](#)

The computer is not accessing the hard disk or the diskette drive.

Your computer normally loads Windows from the hard disk. If you have a hard disk problem, you will not be able to start the computer. Insert a system diskette into the internal diskette drive and press F10 while you turn on the power.

The computer displays the WARNING RESUME FAILURE message.

The computer was placed in Standby mode and the battery has discharged. Data stored in the computer's memory has been lost.

To charge the battery, leave the computer plugged into a live wall outlet for about three hours. For more information, see [“Power and the batteries” on page 198](#).

The computer displays the Non-System disk or disk error message.

Make sure there is no diskette in the diskette drive. If there is one, remove it and press any key to continue. If pressing any key does not work, press Ctrl, Alt, and Del, or press the reset button to restart the computer.

The Windows® Millennium Edition operating system is not working

Once you are familiar with the desktop and used to the way the operating system responds to your work routine, you can easily detect if the operating system is not working correctly. For example:

- ❖ The operating system fails to start after the Starting Windows Millennium Edition message appears.
- ❖ The operating system takes a long time to start.
- ❖ The operating system responds differently from the normal routine.
- ❖ The screen does not look right.

Unless a hardware device has failed, problems usually occur when you change the system in some way such as installing a new program or adding a device.

If you experience any of these problems, use the options in the Windows® Millennium Edition Startup menu to fix the problem.

Using Startup options to fix problems

If the operating system fails to start properly, you may have to change your system's configuration or verify the startup procedure to fix the problem. To do this, use the options in the Startup menu. This section describes each option and when to use the procedure.

To open the Startup menu:

- 1 Restart your computer.
- 2 Press F8 when your computer starts.

The Windows® Millennium Edition Startup menu displays these options:

- ❖ Normal
- ❖ Logged (BOOTLOG.TXT)
- ❖ Safe mode
- ❖ Step-by-step confirmation



TECHNICAL NOTE: If your computer is connected to a network, the Startup menu may display different versions of Safe mode.

Normal

Selecting Normal starts the operating system under normal conditions. Start the computer in Normal mode when there are no apparent problems with the system.

Logged (Bootlog.txt)

Selecting Logged starts the operating system under normal conditions and creates a hidden startup log file named C:\Bootlog.txt. This file records every step of the system's startup process.

You or a qualified Windows® Millennium Edition operating system expert can use this log file to check the loading and initializing of device drivers.



DEFINITION: A device driver is a file that contains information to help the computer's BIOS (Basic Input/Output System) control the operation of devices connected to the system.

Safe mode

Selecting Safe mode bypasses basic startup files and starts the operating system, enabling only the mouse, keyboard, and standard VGA display drivers.

Running Safe mode allows you to undo any changes you made to the system configuration that may have caused the system or a device to fail. For example, if you choose a screen resolution that is not supported by the display, the operating system will have a problem starting correctly. Safe mode bypasses the setting and allows you to change the screen resolution to one supported by the display. Once you have done this, the operating system will start correctly.

Other problems may involve a device driver. See “[The Windows® Millennium Edition operating system can help you](#)” on page 193 to fix the problem.



TECHNICAL NOTE: The Windows® Millennium Edition operating system automatically starts in Safe mode if it detects that system startup failed or the Registry (the file that defines how the operating system is set up) is corrupted.

Step-by-step confirmation

When you turn on your computer, the operating system processes the start-up files. With Step-by-step confirmation, the system asks you to confirm each line of the start-up process once it appears.

Use this option:

- ❖ When the start-up process fails while loading the start-up files
- ❖ To verify all drivers are being loaded
- ❖ To temporarily disable one or more specific driver(s)
- ❖ To check for errors in the start-up files

The operating system uses a file called `io.sys`, which contains all the information needed to start the computer. Although your computer does not need the `Config.Sys` and `Autoexec.Bat` files to start, it does process these files to support backward compatibility

with some programs and device drivers. The same holds true for the System.Ini and Win.Ini files.



TECHNICAL NOTE: Programs and devices that are backward compatible are designed to work with older operating systems and other programs. For example, many features of the Windows® Millennium Edition operating system are backward compatible with earlier versions of the operating system. This lets you use older programs with the Windows® Millennium Edition operating system.

Most of the information contained in these files is now stored in the Registry, but they are still processed during system startup. Bootlog.Txt file contains a record of all the components and drivers loaded during startup and the status of each. When you select Step-by-step confirmation, you can view all these files one line at a time to help diagnose the cause of a problem.

Internet problems

My Internet connection is very slow.

Many factors contribute to the speed with which you can surf the Internet. They include: modem speed, time of day (when everyone else is surfing, your access can be slow) and popularity of the site. If accessing a particular site is very slow, try later.

My browser can't find the URL address I typed in.

Make sure you separated the domain names of the address with the forward slash (/). Check the spelling of each name and the syntax of the address carefully. A single incorrect letter or missed character, comma instead of period ("dot") or other mistake makes it impossible for your browser to locate the site.

My browser can't find a site I bookmarked.

The World Wide Web is constantly changing. A site you bookmarked yesterday may not be available today or its server may be down for temporary repair. Try again later.

The Windows® Millennium Edition operating system can help you

If Windows® Millennium Edition operating system has started properly, but you still have a problem using your computer, the online Help can assist you in troubleshooting the problem.

To access Windows® Millennium Edition Help:

- 1 Click the **Start** button and click **Help**.
- 2 Click the **Home** tab, then click **Troubleshooting**.
- 3 Double-click a problem you would like help with, and follow the steps on the screen.

Working with troubleshooters

Windows® Millennium Edition Help includes a wide range of helpful troubleshooters that can assist you with many common computer problems. For instance, if you are having difficulty setting up a new printer, the Print troubleshooter can walk you through the setup process step by step. Troubleshooters are available through Windows® Help, and they are constantly updated and supplemented on the Microsoft Support Online Web site.

You can connect to Support Online by clicking the **Search Online Support** button in Windows® Help or by connecting to:

<http://support.microsoft.com/directory/>.

Resolving a hardware conflict

If you receive an error message telling you there is a device driver conflict or a general hardware problem, try using Windows® Millennium Edition Help to troubleshoot the problem first.

For help on hardware conflicts:

- 1 From the **Help** menu, double-click on **Troubleshooting**.
- 2 Click **Hardware and System device problems** and follow the steps.

If there is still a problem, the Windows® Millennium Edition operating system should display a message that explains what the conflict is.

A plan of action

The smooth operation of the system depends on the interaction of all devices, programs, and features. If the system or one of its attached devices isn't working, resolving the problem can be time-consuming and frustrating.

The recommended procedure for getting multiple devices to work together is to add and set up one device at a time. After you add each device, test it to make sure it and all previously connected devices work.

The device most recently connected to the system is the one most likely to be causing a hardware conflict.

Resolving hardware conflicts on your own

Computer components need resources to accomplish a task. A device, such as a disk drive or a modem, needs a channel to the computer's Central Processing Unit (CPU). It also needs a direct channel to the computer's memory to store information as it works. These channels of communication are commonly referred to as system resources.

Interrupt Request Channel

The channel to the CPU is called an Interrupt Request (IRQ) because it interrupts what the processor is doing and requests some of the processor's time. If two or more devices use the same IRQ, the processor does not know which device is asking for attention. This causes a hardware conflict.

Direct Memory Access

Similarly, the data required by the device is stored in a specific place or address in memory called the Direct Memory Access (DMA). The DMA provides a dedicated channel for adapter cards to bypass the microprocessor and access memory directly. If two or more devices use the same DMA, the data required by one device overwrites the data required by the other, causing a hardware conflict.

Plug and Play

With Plug and Play and the Windows[®] Millennium Edition operating system, avoiding hardware conflicts is easy. Plug and Play is a computer standard that helps the system BIOS (basic input/output system) and the operating system to automatically assign resources to Plug and Play-compliant devices. In theory, if every device connected to the computer is Plug and Play-compliant, no two devices will compete for the same system resources. Plug in the device and turn on your computer. The operating system automatically sets up your system to accommodate the new device.

If you install an older (legacy) device that the operating system cannot recognize, it may have difficulty assigning resources to it. As a result, a hardware conflict can occur. To see what resources have been assigned to the device, see [“Checking device properties” on page 197](#).

Resolving conflicts

There are three things you can do to resolve hardware conflicts:

- ❖ **Disable the device.**
For an older device, remove it from the computer. For a Plug and Play device, see “[Fixing a problem with Device Manager](#)” on page 196.
- ❖ **Disable another system component and use its resources for the new device,** see “[Fixing a problem with Device Manager](#)” on page 196.
- ❖ **Reconfigure the device so that its requirements do not conflict.** Refer to the device’s documentation for instructions about changing settings on the device.

Fixing a problem with Device Manager

Device Manager provides a way to check and change the configuration of a device.



CAUTION: Changing the default settings using Device Manager can cause other conflicts that make one or more devices unusable. Device Manager is a configuration tool for advanced users who understand configuration parameters and the ramifications of changing them.

Disabling a device

- 1** Click the **My Computer** icon with the secondary button, then click **Properties**.

The System Properties dialog box appears.

- 2** Click the **Device Manager** tab.
- 3** Select the device and click **Properties**.

A dialog box displays the device’s properties.

- 4 In the General section of the dialog box, check the box next to **Disable in this hardware profile**.
- 5 Click **OK**.

Checking device properties

Device Manager provides a way to view the properties of a device. Properties include the name of the manufacturer, the type of device, the drivers installed, and the system resources assigned to the device.

To check a device's properties:

- 1 Click the **My Computer** icon with the secondary button, then click **Properties**.

The System Properties dialog box appears.

- 2 Click the **Device Manager** tab.
- 3 To view the device(s) installed, double-click the device type.
- 4 To view the properties, double-click the device.

The operating system displays the Device Properties dialog box, which provides various tabs from which to choose. Some of the common ones are:

- ❖ The **General** tab, which provides basic information about the device.
- ❖ The **Resources** tab, which lists the resources assigned to the device. If you have a device conflict, it is shown in the Conflicting device list.
- ❖ The **Drivers** tab, which displays the drivers being used by the device.

For more information about Device Manager, refer to Windows[®] Millennium Edition online help.

Memory card problems

Incorrectly connected or faulty memory modules may cause errors that seem to be device-related. It is worthwhile checking for these first:

1 Click **Start**, then click **Shut Down**.

2 Select **Shut down**, then click **OK**.

The operating system shuts down and turns off the computer automatically.

3 Remove the memory module.

4 Reinstall the memory module, following the instructions in “[Installing additional memory \(optional\)](#)” on page 47, and making sure it is seated properly.

5 Check for the error again.

6 If the error recurs, remove the memory module entirely and check for the error again.

If removing the memory module eliminates the error, the memory module may be faulty. If the error recurs without the memory module installed, the error is not caused by the memory module.

Power and the batteries

Your computer receives its power through the AC adapter and power cable or from the system batteries (main battery and real-time clock (RTC) battery). Power problems are interrelated. For example, a faulty AC adapter or power cable will neither power the computer nor recharge the batteries.

Here are some typical problems and how to solve them:

The AC power light does not come on when you plug in the AC adapter and power cable.

Make sure the AC adapter and power cable are firmly plugged into both the wall outlet and the computer.

If the AC power light still does not come on, check that the wall outlet is working properly by plugging in a lamp or other appliance.

The AC adapter and power cable work correctly, but the battery will not charge.

The battery doesn't charge while the computer is consuming full power. Try turning off the computer.

The main battery may not be inserted correctly in the computer. Turn off the computer, remove the battery, clean the contacts with a soft dry cloth (if necessary) and replace the battery.

The battery may be too hot or too cold to charge properly. Its temperature needs to be in the range of 50 degrees to 88 degrees Fahrenheit (10 degrees to 30 degrees Celsius). If you think this is the probable cause, let the battery reach room temperature and try again.

If the battery has completely discharged, it will not begin charging immediately. Leave the AC adapter and power cable connected, wait 20 minutes and see if the battery is charging.

If the battery light is glowing after 20 minutes, let the computer continue charging the battery for at least another 20 minutes before you turn on the computer.

If the battery light does not glow after 20 minutes, the battery may have reached the end of its useful life. Try replacing it.

The battery appears not to power the computer for as long as it usually does.

If you frequently recharge a partially charged battery, it may not charge fully. Let the battery discharge completely, then try charging it again.

Check the power options using the Windows[®] Millennium Edition Power Management utility. Have you added a device, such as a PC Card or memory module, that takes its power from the battery? Is your software using the hard disk more? Is the display power set to turn off automatically? Was the battery fully charged to begin with? All these conditions affect how long the charge lasts.

For more information on maximizing battery power, see [“Charging batteries” on page 91](#).

Keyboard problems

If, when you type, strange things happen or nothing happens, the problem may be related to the keyboard itself.

The keyboard produces unexpected characters.

A keypad overlay may be on. If the numeric keypad or cursor control light is on, press Fn and F10 simultaneously to turn off the cursor control light or press Fn and F11 simultaneously to turn off the numeric keypad light.

If the problem occurs when both the keypad overlays are off, make sure the software you are using is not remapping the keyboard.

Refer to the software’s documentation and check that the program does not assign different meanings to any of the keys.

You have connected an external keyboard and the operating system displays one or more keyboard error messages.

If you have a second keyboard, try it. If it works, the first keyboard may be defective or incompatible with your computer.

Nothing happens when you press the keys on the external keyboard.

The computer may not recognize your USB keyboard. Removing the USB cable and reinserting it into the computer should make the computer recognize the keyboard.

The keyboard locks and the computer will not restart.

Make sure the power is on and press the reset button.

AccuPoint II problems

Some of the keyboard problems already listed may affect the AccuPoint II. In addition:

Your finger slides off the AccuPoint II easily.

If the AccuPoint II cap is oily, remove the cap and clean it with a cotton swab dipped in rubbing alcohol.

To remove the cap:

- 1** Firmly grasp the cap and pull it straight up.

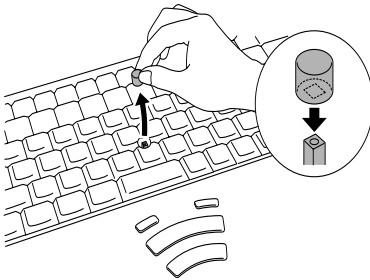

Removing the AccuPoint II cap

- 2 After cleaning the cap, position it on the peg and press it into place.
-



NOTE: The peg is square, so be careful to align the cap's hole with the peg.

Display problems

Here are some typical display problems and their solutions:

The display is blank.

Display Auto Off may have gone into effect. Press any key to activate the screen.

You may have activated the instant password feature by pressing Fn and F1 simultaneously. If you have registered a password, press Enter, type the password and press Enter. If no password is registered, press Enter. The screen reactivates and allows you to continue working.

If you are using the built-in screen, make sure the display priority is not set for an external monitor. To do this, press Fn and F5 simultaneously (once). If this does not correct the problem, press Fn and F5 simultaneously again to return the display priority to its previous setting.

If you are using an external monitor:

- ❖ Check that the monitor is turned on.
- ❖ Check that the monitor's power cable is firmly plugged into a working power outlet.
- ❖ Check that the cable connecting the external monitor to the computer is firmly attached.
- ❖ Try adjusting the contrast and brightness controls on the external monitor.

- ❖ Press Fn and F5 simultaneously to make sure the display priority is not set for the built-in screen.

The screen does not look right.

You can change the display settings by clicking a blank area of the desktop with the AccuPoint II secondary button, then clicking Properties. This opens the Display Properties dialog box. The Appearance tab of this dialog box allows you to choose the colors for the screen. The Settings tab allows you to choose the screen resolution.

The built-in screen flickers.

Some flickering is a normal result of the way the screen produces colors. To reduce the amount of flickering, try using fewer colors.

To change the number of colors displayed:

- 1 Point at the desktop and click with the secondary button.
- 2 Click **Properties**, and then **Settings**.
- 3 Change the Colors option and click **OK**.

For more information, see Windows[®] Help.

A message tells you that there is a problem with your display settings and that the adapter type is incorrect or the current settings do not work with your hardware.

Reduce the size of the color palette to one that is supported by the computer's internal display.

To change the display properties:

- 1 Point at the desktop and click with the secondary button.
- 2 Click **Properties**, and then **Settings**.
- 3 Change the Colors option and click **OK**.

The display mode is set to Simultaneous and the external display device does not work.

Make sure the external monitor is capable of displaying at resolutions of 800 x 600 or higher. Devices that do not support this resolution will only work in Internal/External mode.

Disk drive problems

Problems with the hard disk or with a diskette drive usually show up as an inability to access the disk or as sector errors. Sometimes a disk problem may cause one or more files to appear to have garbage in them. Typical disk problems are:

You are having trouble accessing a disk, or one or more files appear to be missing.

Make sure you are identifying the drive by its correct name (D: or C:).

Run ScanDisk, which analyzes the directories, files and File Allocation Table (FAT) on the disk and repairs any damage it finds.

To run ScanDisk:

- 1** Click **Start**, point to **Programs, Accessories, System Tools**, and click **ScanDisk**.
- 2** Click the drive you want to test.
- 3** Select the type of test you want to use.

A thorough test is more complete but takes much more time than a standard test.

- 4** Click **Start**.

ScanDisk tests the disk.

Your hard disk seems very slow.

If you have been using your computer for some time, your files may have become fragmented. Run Disk Defragmenter. To do this, click **Start**, point to **Programs, Accessories, System Tools**, and click **Disk Defragmenter**.

Your data files are damaged or corrupted.

Refer to your software documentation for file recovery procedures. Many software packages automatically create backup files.

You may also be able to recover lost data using utility software, which is available from your dealer.

Some programs run correctly but others do not.

This is probably a configuration problem. If a program does not run properly, refer to its documentation and check that the hardware configuration meets its needs.

A diskette will not go into the diskette drive.

You may already have a diskette in the drive. Make sure the drive is empty.

You may be inserting the diskette incorrectly. Hold the diskette with the hub side facing down, and insert it so that the metal head window cover goes into the drive first.

The metal cover or a loose label may be obstructing the path into the drive. Carefully inspect the diskette. If the metal cover is loose, replace the diskette. If the label is loose, replace the label and try inserting the diskette again.

The computer displays the Non-system disk or disk error message.

If you are starting the computer from the hard disk, make sure there is no diskette in the diskette drive.

If you are starting the computer from a diskette, the diskette in the drive does not have the files necessary to start the computer. Replace it with a bootable diskette.

The drive cannot read a diskette.

Try another diskette. If you can access the second diskette, the first diskette (not the drive) is probably causing the problem. Run ScanDisk on the faulty diskette (for instructions, see [“Disk drive problems” on page 204](#)).

CD-ROM or DVD-ROM drive problems

You cannot access a disc in the drive.

Make sure the drive tray has closed properly. Press gently until it clicks into place.

Open the drive tray and remove the disc. Make sure the drive tray is clean. Any dirt or foreign object can interfere with the laser beam.

Examine the disc to see whether it is dirty. If necessary, wipe it with a clean cloth dipped in water or a neutral cleaner.

Replace the disc in the tray. Make sure it is lying flat, label side uppermost. Press the disc down until it locks on the spindle. Close the drive tray carefully, making sure it has shut completely.

You press the disc eject button, but the drive tray does not slide out.

Make sure the computer is connected to a power source and turned on. The DVD-ROM drive eject mechanism requires power to operate.

To remove a disc without turning on the computer, use a narrow object, such as a straightened paper clip, to press the manual eject button. This button is in the small hole next to the disc eject button on the right side of the computer.

Some discs run correctly, but others do not.

If the problem is with an application CD-ROM, refer to the software's documentation and check that the hardware configuration meets the program's needs.

The color of the materials used to make the disc can affect its reliability. Silver-colored CD-ROMs are the most reliable, followed by gold-colored CD-ROM. Green-colored CD-ROMs are the least reliable.

WinDVD problems: General issues

WinDVD has been configured to provide optimum performance and quality based upon your system's available resources. Changes made to the system or its configuration may impact the playback performance of the WinDVD player.

WinDVD controls are disabled.

Controls may be grayed out by commands on the DVD. For example, it is common for DVD movie titles to disable fast-forward and rewind during the legal notices at the beginning of a movie.

Playback performance is poor.

The use of DMA dramatically increases the DVD playback performance of your system.

To make sure DMA is turned on and to check its settings:

- 1 Open the **Start** menu, point to **Settings**, then click **Control Panel**.
- 2 Double-click the **System** icon, then select the **Device Manager** tab.
- 3 Open the **CD-ROM** device folder, select your DVD-ROM device driver, then click **Properties**.

- 4 Select the **Settings** tab, click the **DMA** check box, then click **OK**.

The system must be restarted for this setting to take effect.

The Root or Title menu does not open.

Most DVD titles have one or both of the “Root” and “Title” menus. If one menu button appears to do nothing, try the other menu button.

WinDVD performance decreases after making a system change.

DVD playback performance is dependent upon several system resources. Changes to these system resources caused, for example, by installing a new graphics or audio card may impact performance. Some software changes may also impact playback performance (for example, downloading new drivers from the Web).

Before installing a new hardware or software component on your system, check for any potential conflicts between its resource requirements and your current system configuration. Also, if you change your Operating System, check with your PC manufacturer or your graphics card vendor to ensure that you have the appropriate drivers for both your hardware (for example, the graphics card) and software (drivers must support the Operating System and DVD with WinDVD).

Slow playback performance.

DVD playback is a resource intensive application. Other applications and/or changes to your system hardware, software or configuration can impact playback performance. If playback is slower than normal, try:

- 1 Closing any other open applications to improve the performance of the DVD playback.
- 2 Ensuring DMA is turned on. (See [“Playback performance is poor.”](#) on page 207.)

- 3** If you have installed new hardware (such as a new graphics card or audio card), ensure the component's drivers support Microsoft® DirectX® 5.2b or higher and WinDVD. Contact the manufacturer of the component.
- 4** Verifying that your display driver resolution, color depth and refresh rate are optimal for DVD playback. (Some systems do not support video overlays if these parameters are not optimal.) Try lowering these settings to improve performance.

WinDVD problems: Content issues

Movies exhibit poor performance of “Director's Commentary” or other similar optional content versions.

Some movies may exhibit poor performance of these features. In particular, the video portion of the movie may become jerky or show pauses. The normal version of the movie will not show this problem.

WinDVD will not function properly with “debug” software installed.

The WinDVD application will not function properly if it detects that debug software is present on the system. Remove the debug software to restore functionality of WinDVD.

Minimum system requirements

WinDVD performs best when these recommended components are present in your system:

- ❖ Sound card (with 48 KHz sampling rate support)
- ❖ DirectX® Foundation 6.0 or higher (Source: Microsoft)
- ❖ DirectShow® 6.0 (Source: Microsoft)
- ❖ DVD-ROM drive with DMA enabled (only available with Microsoft OSR 2.1 or above with PIXX 4.0 and USB support added)

❖ WinDVD software

WinDVD: Error messages

This table offers descriptions and resolutions for error messages that may appear when using WinDVD.

<i>Error message and additional information</i>	<i>Resolution</i>
<p>The disc in the DVD-ROM drive is not a valid disc type.</p> <p>Valid disc types are DVD-Video, Video CD, and audio CD.</p>	<p>Ensure the disc is a valid disc type.</p> <p>If the disc works in other players, try using a disc cleaner.</p> <p>The disc may require features that are not supported by WinDVD.</p>
<p>Microsoft® DirectShow® components are missing.</p> <p>Microsoft® DirectShow® is not installed properly on the system.</p>	<p>Reinstall Microsoft® DirectShow® version 6.0 or higher (available from the Microsoft Web site).</p>
<p>No audio subsystem could be found for playback.</p> <p>There is a problem with the audio card or audio component within the system. The problem may be one of the following:</p> <p>The audio card is faulty.</p> <p>There is a problem with the audio driver.</p>	<p>Check installation of the sound card drivers.</p>

<i>Error message and additional information</i>	<i>Resolution</i>
<p>WinDVD cannot display the selected resolution due to system limitations.</p> <p>The screen size exceeds the allowable display limit. There are not enough system resources to play the DVD at the selected setting.</p>	<p>Alter the display settings to reduce the resolution or number of colors.</p> <p>Update video drivers.</p>
<p>The audio settings are incorrect. Please check sound card or drivers.</p> <p>The audio card was found, but there is a problem with the audio card or drivers. The wrong audio driver may be installed in the system.</p>	<p>Check installation of audio card drivers.</p>
<p>An unexpected error has occurred.</p> <p>This error is unclassified. Report the problem and any error code to your supplier's Technical Support.</p>	<p>This is usually a rare, title-specific problem.</p>
<p>There is a problem with the copy protection system within the DVD-ROM drive. Playback cannot continue.</p> <p>The DVD-ROM drive failed to authenticate (authorize playback of) the DVD disc. There may be a problem with the DVD-ROM drive.</p>	<p>Try to play another disc. Contact your supplier's Technical Support.</p>

<i>Error message and additional information</i>	<i>Resolution</i>
WinDVD does not support this version of the DVD specification.	Check that this is a DVD-Video 1.0 disc.
<p>This DVD disc cannot be played in this region.</p> <p>The selected region cannot be used due to one of the following:</p> <p>The Region Code of WinDVD and the DVD disc do not match. Check the Region Code of WinDVD within the About tab and use a disc from the appropriate region.</p> <p>The Windows operating system is assigned to a region that does not match the Region Code of WinDVD.</p>	Use DVD content from the appropriate region. If applicable on your system, refer to the Help file for how to change the Region Code.
<p>Permission to play is denied. Please check the Parental Control setting.</p> <p>The Parental Control setting of WinDVD is lower than the Parental Control level of the content being played. Playback of the DVD disc is not authorized.</p>	Change the Parental Control level in the DVD Options dialog. Note that WinDVD requires a password for this change.
WinDVD encountered an error.	Report the problem and any error code to your supplier's Technical Support.

<i>Error message and additional information</i>	<i>Resolution</i>
This file appears to contain unsupported data.	Please refer to the Supported Formats section of the WinDVD Help file and ensure that this file contains valid data.
The drive or disc cannot be found. This may be caused by one of the following: No disc in the DVD-ROM drive. No DVD-ROM drive. A disc of an unsupported type in the DVD-ROM drive.	Check the DVD-ROM drive or DVD disc. Ensure the disc is a valid type (DVD-Video, Video-CD, or audio CD).

Sound system problems

You do not hear any sound from the computer.

Adjust the volume control.

If you are using external headphones or speakers, check that they are securely connected to your computer.

The computer emits a loud, high-pitched noise.

This is feedback between the microphone and the speakers. It occurs in any sound system when input from a microphone is fed to the speakers and the speaker volume is too loud. Adjust the volume control.

Changing the settings for the Record Monitor feature in the Recording Control Utility (default Off), or the Mute feature in the Mixer Utility (default Enabled), may cause feedback. Revert to the default settings.

PC Card problems

PC Cards (PCMCIA-compatible) include many types of devices, such as a removable hard disk, additional memory, or a pager.

Most PC Card problems occur during installation and setup of new cards. If you're having trouble getting one or more of these devices to work together, several sections in this chapter may apply.

Resource conflicts can cause problems when using PC Cards. See [“Resolving a hardware conflict” on page 194](#).

Card Information Structure

When you insert a PC Card into a slot, the computer attempts to determine the type of card and the resources it requires by reading its Card Information Structure (CIS). Sometimes the CIS contains enough information for you to use the card immediately.

Other cards must be set up before you can use them. Use the Windows® Millennium Edition PC Card (PCMCIA) Wizard to set up the card. Refer to your Microsoft documentation for more information, or refer to the documentation that came with the PC Card.

Some card manufacturers use special software called *enablers* to support their cards. Enablers result in nonstandard configurations that can cause problems when installing the PC Card.

If your system does not have built-in drivers for your PC Card and the card did not come with a Windows® Millennium Edition driver, it may not work under Windows Millennium Edition. Contact the manufacturer of the PC Card for information about using the card under the Windows® Millennium Edition operating system.

PC Card checklist

- ❖ Make sure the card is inserted properly into the slot.

See “[Using PC Cards](#)” on page 159 for how to insert PC Cards.

- ❖ Make sure all cables are securely connected.
- ❖ Make sure the computer is loading only one version of Card and Socket Services.
- ❖ Occasionally a defective PC Card slips through quality control. If another PCMCIA-equipped computer is available, try the card in that machine. If the card malfunctions again, it may be defective.

Resolving PC Card problems

Here are some common problems and their solutions:

The slots appear to be dead. PC Cards that used to work no longer work.

Check the PC Card status:

- 1** Click the **My Computer** icon with the secondary button, then click **Properties**.

The System Properties dialog box appears.

- 2** Click the **Device Manager** tab.

- 3** Double-click the device listed as your PC Card.

The operating system displays your PC Card’s Properties dialog box, which contains information about your PC Card configuration and status.

The computer stops working (hangs) when you insert a PC Card.

The problem may be caused by an I/O (input/output) conflict between the PCMCIA socket and another device in the system. Use Device Manager to make sure each device has its own I/O base address. See “[Fixing a problem with Device Manager](#)” on page 196 for more information.

Since all PC Cards share the same socket, each card is not required to have its own address.

Hot swapping (removing one PC Card and inserting another without turning the computer off) fails.

Follow this procedure before you remove a PC Card:

- 1 Click the **PC Card** icon on the taskbar.
- 2 Click **Stop xxxx**, where *xxxx* is the identifier for your PC Card.

Windows Millennium Edition displays a message that you may safely remove the card.

- 3 Remove the card from the slot.

The system does not recognize your PC Card or PCMCIA socket controller.

This problem may be caused by a low battery. Charge the battery fully:

- 1 Make sure the computer is not in Standby mode. For more information, see [“Using Standby” on page 88](#).
- 2 Turn off the computer.
- 3 Connect the AC adapter and power cable.
- 4 Keep the computer plugged in for about three hours with the power turned off.

The problem may also be caused by a conflict with any additional memory in your system.

Removing a malfunctioning card and reinstalling it can correct many problems. For more information, see [“Using PC Cards” on page 159](#).

A PC Card error occurs.

Reinsert the card to make sure it is properly connected.

If the card is attached to an external device, check that the connection is secure.

Refer to the card's documentation, which should contain a troubleshooting section.

Printer problems

This section lists some of the most common printer problems:

The printer will not print.

Check that the printer is connected to a working power outlet, turned on and ready (on line).

Check that the printer has plenty of paper. Some printers will not start printing when there are just two or three sheets of paper left in the tray.

Make sure the printer cable is firmly attached to the computer and the printer.

If your printer is ECP- or IEEE 1284-compliant, make sure you have an IEEE 1284 printer cable.

Run the printer's self-test to check for any problem with the printer itself.

Make sure you installed the proper printer drivers, as shown in [“Setting up a printer” on page 58](#).

You may have connected the printer while the computer is on. Disable Standby mode, turn off the computer, and turn off the printer. Turn the printer back on, make sure it is on line, then turn the computer back on.

Try printing another file. For example, you could create and attempt to print a short test file using Notepad. If a Notepad file prints correctly, the problem may be in your original file.

Contact your network administrator if the printer is on your office network.

The printer will not print what you see on the screen.

Many programs display information on the screen differently from the way they print it. See if your program has a print preview mode. This mode lets you see your work exactly as it will print. Contact the software manufacturer for more information.

Modem problems

This section lists common modem problems:

The modem will not receive or transmit properly.

Make sure the cable from the modem to the telephone line is firmly connected to the computer's modem port and the telephone line jack.

Check the serial port settings to make sure the hardware and software are referring to the same COM port (look in Device Manager under Modems for the built-in modem).

Check the communications parameters (baud rate, parity, data length and stop bits) specified in the communications program. It should be set up to transmit at 300, 1200, 2400, 4800, 9600, 14400, 28800, 33600 bps (bits per second) or higher. Refer to the program's documentation and the modem manual for information on how to change these settings.

The modem is on, set up properly and still will not transmit or receive data.

Make sure the line has a dial tone. Connect a telephone handset to the line to check this.

The other system may be busy or off line. Try making a test transmission to someone else.

Develop good computing habits

Make sure you are prepared.

Save your work frequently.

You can never predict when your computer will lock, forcing you to close a program and lose unsaved changes. Many software programs build in an automatic backup, but you should not rely solely on this feature. Save your work! See “[Computing tips](#)” on [page 65](#) for instructions.

On a regular basis, back up the information stored on your hard disk.

Here are some ways you can do this:

- ❖ Copy files to diskette in with the operating system, following the steps in “[Saving your work](#)” on [page 70](#).
- ❖ Connect a tape drive to the system and use specialized software to copy everything on the hard disk to a tape.

Some people use a combination of these methods, backing up all files to tape weekly and copying critical files to diskette on a daily basis.

If you have installed your own programs, you should back up these programs as well as your data files. If something goes wrong that requires you to reformat your hard disk and start again, reloading all your programs and data files from a backup source will save time.

Read the user’s guides.

It’s very difficult to provide a fail-safe set of steps you can follow every time you experience a problem with the computer. Your ability to solve problems will improve as you learn about how the computer and its software work together.

Get familiar with all the user’s guides provided with your computer, as well as the manuals that come with the programs and devices you purchase.

Your local computer store or book store sells a variety of self-help books you can use to supplement the information in the manuals.

Using VirtualTech

VirtualTech is a suite of innovative support resources and tools installed on your computer. VirtualTech will make your computing experience easier and more fulfilling by assisting you when you have questions, run into problems, or need help with your computer or programs.



To access VirtualTech, double-click the VirtualTech icon located on your computer's desktop.

Here is a summary of the kinds of resources and tools VirtualTech has to offer:

- ❖ A library of solutions to common computer problems. These are arranged in easy to navigate topics like software, hardware and the Internet.
- ❖ A set of powerful support tools that can:
 - ❖ Retrieve hardware and software details whenever you need system configuration information.
 - ❖ Provide a real time view of your machine's condition and running applications. VirtualTech can take up to 10 "snapshots" of your applications to ensure you can restore your configuration and replace or repair damaged files.
 - ❖ Check and inform you of any updates whenever you go online. To load an update, click **yes**.
 - ❖ Run a detailed system report that harvests and compiles your system's hardware and software information. This report is also accessible to Toshiba's InTouch Center technicians to reference when you place a call or send a question electronically.
 - ❖ Direct you to Ask IRIS Online™, Toshiba's instant response information service where you can ask questions and receive answers.

- ❖ Send a message electronically with your questions directly to our InTouch Center. A representative will address your situation and contact you.

If you need further assistance

If you have followed the recommendations in this chapter and are still having problems, you may need additional technical assistance. This section contains the steps to take to ask for help.

Before you call

Since some problems may be related to the operating system or the program you are using, it is important to investigate other sources of assistance first.

Try the following before contacting Toshiba:

- ❖ Review the troubleshooting information in your Windows Millennium Edition documentation.
- ❖ If the problem occurs while you are running a program, consult the program's documentation for troubleshooting suggestions. Contact the software company's technical support group for their assistance.
- ❖ Consult the dealer from whom you purchased your computer and/or program. Your dealer is your best source for current information.

For the number of a Toshiba dealer near you in the United States, call: (800) 457-7777.

Contacting Toshiba

If you still need help and suspect that the problem is hardware-related, Toshiba offers a variety of resources to help you.

- 1 Start with accessing Toshiba on the Internet using any Internet browser by typing pcsupport.toshiba.com

- 2 Next, try one of Toshiba's online services. The Toshiba Forum can be accessed through CompuServe® by typing:
go toshiba.

Toshiba voice contact

Before calling Toshiba, make sure you have:

- ❖ Your computer's serial number.
- ❖ The computer and any optional devices related to the problem.
- ❖ Backup copies of your Windows operating system and all other preloaded software on diskettes or CD-ROM.
- ❖ Name and version of the program involved in the problem along with its installation diskettes or CD-ROM.
- ❖ Information about what you were doing when the problem occurred.
- ❖ Exact error messages and when they occurred.

For technical support, call the Toshiba InTouch Center:

Within the United States at (800) 457-7777

Outside the United States at (949) 859-4273

Other Toshiba Internet Web sites

toshiba.com	Worldwide Toshiba corporate site
computers.toshiba.com	Marketing and product information in the USA
toshiba.ca	Canada
toshiba-Europe.com	Europe
toshiba.co.jp/index.htm	Japan

Toshiba's worldwide offices

Argentina

Acron, S.A.
Solís 1525
(1134) Buenos Aires
Argentina

Austria

Toshiba Europe GmbH
Niederlassung Österreich
Landstraßer
Hauptstraße 2/259 a - c, A-1030
Wien, Austria

Brazil

Semp Toshiba Informática
Silveria Rodrigues 52
05047-000 Sao Paulo
SP Brazil

Central America & Caribbean

TechData Latin America
8501 NW 17th Street, #101
Miami, FL 33126
United States

Colombia

CHS Promark Colombia Ltda.
Carrera 129, Nro. 2957
Parque Industrial de Occidente
Bodega 30 - Zona Fontibón
Santa Fe de Bogotá, Colombia

Australia

Toshiba (Australia) Pty. Limited
84-92 Talavera Road
North Ryde NSW 2113
Sydney
Australia

Belgium

Toshiba Information Systems
Benelux (Belgium) B.V.
Excelsiorlaan 40
B-1930 Zaventem
Belgium

Canada

Toshiba Canada Ltd.
191 McNabb Street
Markham, Ontario
L3R - 8H2
Canada

Chile

CHS Promark Chile Ltda.
J. Joaquin Aguirre Luco 1339
Huechuraba
Santiago, Chile

Czech Republic

CHG Toshiba, s.r.o.
Hnevkovskeho 65
61700 Brno

Denmark

Scribona Danmark A/S
Naverland 27
DK2600 Glostrup
Denmark

France

Toshiba Systèmes (France) S.A.
7, Rue Ampère
92804 Puteaux Cédex
France

Greece

Ideal Electronics S.A.
109 Syngrou Avenue
176 71 Kalithea
Athens
Greece

Ireland

Same as United Kingdom

Japan

Toshiba Corporation, PCO-IO
1-1, Shibaura 1-Chome
Minato-Ku, Tokyo, 105-8001
Japan

Mexico

Toshiba de Mexico
Paseo de la Reforma no. 30, 4-Piso
Centro 06048 D.F.
Mexico City
Mexico

Finland

Scribona TPC OY
Sinimäentie 14
P.O. Box 83
02630 ESPOO
Finland

Germany

Toshiba Europe GmbH
Leibnizstraße 2
D-93055 Regensburg
Germany

Hungary

Technotrade Kft.
Öv utca 185
1147 Budapest
Hungary

Italy

Progetto Elettronica 92 s.r.l.
Viale Certosa 138,
20156 Milano
Italy

Luxembourg

Same as Belgium

Morocco

C.B.I.
22 Rue de Béthune
Casablanca
Morocco

The Netherlands

Toshiba Information Systems
Benelux B.V.
Rivium Boulevard 41
2909 LK, Capelle a/d IJssel
The Netherlands

Norway

Scribona Norge A/S
Toshiba PC Service
Stalfjaera 20
P.O. Box 51
Kalbakken
0901 OSLO 9
Norway

Poland

TECHMEX S.A.
ul. Partyzantów 71,
43-316 Bielsko-Biala
01-059 Warszawa
Poland

Slovakia

HTC s.r.o.
Kukucinova 26
831 03 Bratislava
Slovakia

Spain

Toshiba Information Systems
(España) S.A.
Parque Empresarial San Fernando
Edificio Europa, 1a Planta
Escalera A
28831 (Madrid) San Fernando de
Henares
Spain

New Zealand

Toshiba (New Zealand) Pty.
Limited
Level 4, 3 Ferncroft Street
Grafton Auckland
New Zealand

Papua New Guinea

Fujitsu (PNG) Pty. Ltd.
P.O. Box 4952 Boroko
NCD, Papua
New Guinea

Portugal

Quinta Grande Assistência Técnica
Informática, Lda.
Av. Moinhos no. 15A
Ur. Quinta Grande
2720 Alfragide
Portugal

Slovenia

Inea d.o.o.
Ljubljanska 80
1230 Domzale
Slovenia

Sweden

Scribona PC AB
Sundbybergsvägen 1
Box 1374
171 27 Solna
Sweden

Switzerland

Ozalid AG
Herostrasse 7
8048 Zürich
Switzerland

United States

Toshiba America Information
Systems, Inc.
9740 Irvine Boulevard
Irvine, California 92618
United States

United Kingdom

Toshiba Information Systems
(U.K) Ltd.
Toshiba Court
Weybridge Business Park
Addlestone Road
Weybridge KT15 2UL
United Kingdom

Venezuela

InterPC de Venezuela
Esquina Calle 4 y Calle 8
Edificio Tepal - Piso 3
La Urbina
Caracas 1073 - Venezuela

Appendix A

Hot Keys

Hot keys are keys that, when pressed in combination with the Fn key, turn system functions on and off. Hot keys have a legend on or above the key indicating the option or feature the key controls.

Instant password security

Fn +  This hot key blanks the display.

To resume working, if you have registered a user password, press Enter, type your password and press Enter. If there is no registered password, press Enter.

Do not confuse the instant password security feature with:

- ❖ The Windows screen saver feature that merely blanks the display after a specified amount of time (and needs no password to resume operation),
or
- ❖ The use of an invalid Display mode hot key (Fn + F5) setting.

Sound

Fn +  This hot key cycles through the different alarm volume levels.

The alarm volume options are:
Off, Low, Medium, and High.

Off is always first.

Display modes

Fn +  This hot key cycles through the power-on display mode options.

The display mode options are:

Built-in display panel only, Built-in display panel and external monitor simultaneously, External monitor only, Built in display panel and TV (or other external video device) simultaneously, and TV (or other external video device) only.





TECHNICAL NOTE: In order to use simultaneous mode, you must set the resolution of the built-in display panel to match the resolution of the external display device.

Simultaneous mode works only with external monitors that support 640 X 480 resolution and higher.

Keyboard hot keys

Fn +  This hot key turns the cursor control overlay on and off.

Fn +  This hot key turns the numeric overlay on and off.

Fn +  This hot key turns the scroll lock feature on and off.

For more information, see [“Overlay keys”](#) on page 68.

Appendix B

Power Cable Connectors

Your notebook computer features a universal power supply you can use worldwide. This appendix shows the shapes of the typical AC power cable connectors for various parts of the world.

USA and Canada



UL approved
CSA approved

United Kingdom

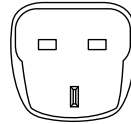

BS approved

Australia



AS approved

Europe



VDA approved
NEMKO approved

— Blank Page —

Glossary



TECHNICAL NOTE: Some features defined in this glossary may not be available on your computer.

Acronyms

The following acronyms may appear in this user's guide.

AC	alternating current
BIOS	basic input/output system
bps	bits per second
CD	compact disc
CD-ROM	compact disc read-only memory
CD-RW	compact disc rewrite memory
CMOS	complementary metal-oxide semiconductor
COM1	communications port 1 (serial port)
COM2	communications port 2 (serial port)
CPU	central processing unit
DC	direct current

DMA	direct memory access
DIMM	dual inline memory module
DOS	disk operating system
DPI	dots per inch
DSTN	dual supertwist nematic
DVD	digital versatile (or video) disc
DVD-ROM	digital versatile (or video) disc read-only memory
ECP	enhanced capabilities port
EPROM	erasable programmable read-only memory
FAT	file allocation table
FCC	Federal Communications Commission
FIR	fast infrared
GB	gigabyte
HDD	hard disk drive
HTML	Hypertext Markup Language
IEEE	Institute of Electrical and Electronics Engineers
I/O	input/output
IRQ	interrupt request
ISP	Internet service provider
KB	kilobyte
LAN	local area network
LCD	liquid crystal display
LPT1	line printer port 1 (parallel port)
LSI	large-scale integration
MB	megabyte
MIDI	Musical Instrument Digital Interface
PC	personal computer
PCI	Peripheral Component Interconnect
PCMCIA	Personal Computer Memory Card International Association
RAM	random access memory

RFI	radio frequency interference
ROM	read-only memory
RTC	real-time clock
SCSI	small computer system interface
SDRAM	synchronous dynamic random access memory
SRAM	static random access memory
SVGA	super video graphics adapter
TFT	thin film transistor
USB	universal serial bus
URL	uniform resource locator
WAN	wide area network
www	World Wide Web

Terms

The following terms may appear in this user's guide.

A

active-matrix display — A liquid crystal display (LCD) made from an array of liquid crystal cells using active-matrix technology. Also known as a “TFT display,” in its simplest form there is one thin film transistor (TFT) for each cell. This type of display works well with notebook computers because of its shallow depth and high-quality color. Active-matrix displays are viewable from wider angles than most passive-matrix displays.

adapter — A device that provides a compatible connection between two units. For example, the computer's internal display adapter receives information from the software and translates it into images on the screen. An adapter can take a number of forms, from a microprocessor to a simple connector. An intelligent adapter (one that is capable of doing some processing) may also be called a controller.

alternating current (AC) — The type of power usually supplied to residential and commercial wall outlets. AC reverses its direction at regular intervals. Compare *direct current (DC)*.

application — A computer program that you use to perform tasks of a specific type. Applications include word processors, spreadsheets, and database management systems. See also *program*.

B

backup — A copy of a file, usually on a removable disk, kept in case the original file is lost or damaged.

basic input/output system (BIOS) — See *BIOS*.

baud rate — The speed at which a communication device, such as a printer or modem, transmits information. Baud rate is the number of signal changes per second (not necessarily the same as bits per second). See also *bits per second*.

BIOS (basic input/output system) — Basic instructions, stored in read-only memory (ROM), containing the information the computer needs in order to check hardware and load the operating system when you start up the computer.

bit: — Short for “binary digit.” A bit is the smallest unit of information used by a computer. A group of eight bits is a byte. See also *byte*.

bits per second (bps) — A way of measuring the speed at which information is passed between two devices. The basic measure used in modem communications, bps is similar, but not identical, to the baud rate. See also *baud rate*.

boot — To start the computer. The term “boot” originates from bootstrap program (as in “pulling itself up by its bootstraps”), a program that loads and initializes the operating system. See also *reboot*.

boot disk — See *system disk*.

boot priority (startup sequence) — The order in which the computer accesses its disk drives to locate the startup files. Under the default startup sequence, the computer looks for the startup files in the diskette drive before checking the hard disk.

bus — An electrical circuit that connects the central processing unit (CPU) with other parts of the computer, such as the video adapter, disk drives, and ports. It is the pathway through which data flows from one device to another. See also *bus speed*, *frontside bus*.

bus speed — The speed at which the central processing unit (CPU) communicates with the other parts of the computer.

byte — A sequence of eight bits. A byte is the smallest addressable unit of data. See also *bit, gigabyte, kilobyte, megabyte*.

C

cache — A section of very fast memory in which frequently used information is duplicated for quick access. Accessing data from cache is faster than accessing it from the computer's main memory. See also *CPU cache, L1 cache, L2 cache*.

CD — An individual compact disc. See also *CD-ROM*.

CD-ROM (compact disc read-only memory) — A form of high-capacity storage that uses laser optics instead of magnetic means for reading data. See also *CD*. Compare *DVD-ROM*.

central processing unit (CPU) — The chip that functions as the “brain” of the computer. It takes information from outside sources, such as memory or keyboard input, processes the information, and sends the results to another device that uses the information.

character — Any letter, number, or symbol you can use on the computer. Some characters are non-printing characters, such as a paragraph break in a word-processing program. A character occupies one byte of computer storage.

chip — A small piece of silicon containing computer logic and circuits for processing, memory, input/output, and/or control functions. Chips are mounted on printed circuit boards.

click — To press and release the AccuPoint control button or mouse button without moving the AccuPoint or mouse. In Windows, this refers to the left mouse button or primary AccuPoint control button, unless otherwise stated. See also *double-click*.

color palette — A set of specified colors that establishes the colors that can be displayed on the screen at a particular time.

compatibility — The extent to which computers, programs, or devices can work together harmoniously, using the same commands, formats, or language as another.

configuration — (1) The collection of components that make up a single computer system. (2) How parts of the system are set up (that is, configured).

controller — A device that controls the transfer of data from a computer to a peripheral device and vice versa. For example, disk drives, monitors, keyboards, and printers all require controllers.

CPU — See *central processing unit (CPU)*.

CPU cache — A section of very fast memory residing between the CPU and the computer's main memory that temporarily stores data and instructions the CPU will need to execute commands and programs. See also *cache, L1 cache, L2 cache*.

cursor — A symbol that indicates the current position on the screen. The shape of the cursor varies, depending on the program you're using and what you're doing.

D

default — The setting selected by a program when the user does not specify an alternative setting.

device — A component attached to the computer. Devices may be external (outside the computer's case) or internal (inside the computer's case). Printers, disk drives, and modems are examples of devices.

device driver — A program (called a "driver") that permits a computer to communicate with a device.

dialog box — An on-screen window displayed by the operating system or a program giving a direction or requesting input from the user.

direct current (DC) — The type of power usually supplied by batteries. DC flows in one direction. Compare *alternating current (AC)*.

direct memory access (DMA) — A dedicated channel, bypassing the CPU, that enables direct data transfer between memory and a device.

directory — See *folder*.

disable — To turn a computer option off. See also *enable*.

disc — A round, flat piece of metal, designed to be read from and written to by optical (laser) technology, and used in the production of optical discs, such as CDs and DVDs. Compare *disk*.

disk — A round, flat piece of material that can be magnetically influenced to hold information in digital form, and used in the production of magnetic disks, such as diskettes and hard disks. Compare *disc*. See also *diskette, hard disk*.

disk drive — The device that reads and writes information and programs on a diskette or hard disk. It rotates the disk at high speed past one or more read/write heads.

diskette — A thin, flexible disk in a protective jacket that stores magnetically encoded data. Diskettes can be removed from the computer and come in two sizes: 5.25-inch and 3.5-inch. Your computer uses 3.5-inch diskettes. See also *double-density diskette*, *high-density diskette*.

document — Any file created with an application and, if saved to disk, given a name by which it can be retrieved. See also *file*.

double-click — To press the AccuPoint control button or mouse button rapidly twice without moving the AccuPoint or mouse. In Windows, this refers to the primary AccuPoint control button or left mouse button, unless otherwise stated.

double-density diskette — A 3.5-inch diskette that can hold up to 720 KB of information (half the capacity of a high-density diskette). See also *diskette*, *high-density diskette*.

download — (1) In communications, to receive a file from another computer through a modem or network. (2) To send font data from the computer to a printer. See also *upload*.

drag — To hold down the AccuPoint control button or mouse button while moving the cursor to drag a selected object. In Windows, this refers to the primary AccuPoint control button or left mouse button, unless otherwise stated.

driver — See *device driver*.

DVD — An individual digital versatile (or video) disc. See also *DVD-ROM*.

DVD-ROM (digital versatile [or video] disc read-only memory) — A very high-capacity storage medium that uses laser optics for reading data. Each DVD-ROM can hold as much data as several CD-ROMs. Compare *CD-ROM*.

E **emulation** — A technique in which a device or program imitates another device or program.

enable — To turn on a computer option. See also *disable*.

executable file — A computer program that is ready to run. Application programs and batch files are examples of executable files. Names of executable files usually end with a .bat or .exe extension.

expansion device — A device that connects to a computer to expand its capabilities. Other names for an expansion device are port expander, port replicator, docking station, or network adapter.

extension — See *file extension*.

external device — See *device*.

F

file — A collection of related information, saved on disk with a unique name. A file may be a program, information used by a program, or a document. See also *document*.

file allocation table (FAT) — The section of a disk that keeps track of the location of files stored on the disk.

file name — A set of characters that uniquely identifies a file within a particular folder. It consists of two parts: the actual name and the file name extension. See also *file extension*.

file extension — The three characters following the period (pronounced “dot”) at the end of a file name. The extension indicates the type of file. Examples are .exe for program files and .hlp for help files. See also *file name*.

folder — Also called directory. A container for organizing files saved to a disk. A folder is symbolized on screen by a graphical image (icon) of a file folder. A folder can contain files and other folders.

format — (verb) To prepare a blank disk for use with the computer’s operating system. Formatting creates a structure on the disk so the operating system can write information to the disk or read information from it.

frontside bus — The primary pathway (bus) between the CPU and the computer’s main memory. Also called “system bus.” See also *bus*.

function keys — The keys labeled F1 through F12, typically located on the keyboard. Their function is determined by the operating system and/or individual programs.

G

gigabyte (GB) — A unit of data equal to 1,073,741,824 bytes (1024 x 1024 x 1024 bytes). See also *byte*.

ground — A conductor to which all components of an electric circuit are connected. It has a potential of zero (0) volts, is connected to the earth, and is the point of reference for voltages in the circuit.

H

hard disk — A storage device composed of a rigid platter or platters that can be magnetically coded with data. Hard disks hold much more information than diskettes and are used for long-term storage of programs and data. The primary (or only) hard disk in a computer is usually fixed, but some computers have secondary hard disks that are removable. By default, the hard disk is referred to as drive C.

hardware — The physical components of a computer system. Compare *software*.

Hibernation — A feature of many Toshiba notebook computers that saves to the hard disk the current state of your work, including all open files and programs, when you turn the computer off. When you turn on the computer again, your work is returned to the same state it was when the computer was turned off. See also *Standby*, *Suspend*.

high-density diskette — A 3.5-inch diskette that holds 1.44 MB of data. See also *diskette*.

hot key — (1) A feature in which certain keys in combination with the Fn key can set system options or control system parameters, such as the battery save mode. (2) A key or combination of keys that activates a memory resident program.

hot swapping — The ability to add or remove devices from a computer while the computer is running and have the operating system automatically recognize the change.

icon — A small image displayed on the screen that represents a function, file, or program.

interlaced — A method of refreshing a computer screen, in which only every other line of pixels is refreshed. Interlaced monitors take two passes to create a complete screen image. Compare *non-interlaced*.

internal device — See *device*.

Internet — The decentralized, world-wide network of computers that provides electronic mail, the World Wide Web, and other services. See also *World Wide Web*.

K

keyboard shortcut — A key or combination of keys that you use to perform a task instead of using a pointing device such as the AccuPoint.

kilobyte (KB) — A unit of data equal to 1024 bytes. See also *byte*.

L

L1 (level one) cache — Memory cache built into the processor to help improve processing speed. See also *cache*, *CPU cache*, *L2 cache*.

L2 (level two) cache — Memory cache installed on the motherboard to help improve processing speed. It is slower than L1 cache and faster than main memory. See also *cache*, *CPU cache*, *L1 cache*.

LAN (local area network) — A group of computers or other devices dispersed over a relatively limited area and connected by a communications link that enables any device to interact with any other on the network.

liquid crystal display (LCD) — A type of display that uses a liquid substance between two transparent electrode panels. When an electric current passes through the electrodes, the molecules in the liquid form a crystalline pattern that polarizes the light passing through it. A filter over the electrodes permits only non-polarized light to pass to the surface of the display, creating light and dark pixels.

load — To move information from a storage device (such as a hard disk) into memory for processing.

local area network — See *LAN*.

logical drive — A section of a disk that is recognized by the operating system as a separate disk drive. A system's logical drives may differ from its physical drives. For example, a single hard disk drive may be partitioned into two or more logical drives.

M

megabyte (MB) — A unit of data equal to 1,048,576 bytes (1024 x 1024 bytes). See also *bytes*.

memory — Typically refers to the computer's main memory, where programs are run and data is temporarily stored and processed. Memory can be volatile and hold data temporarily, such as RAM, or it can be nonvolatile and hold data permanently, such as ROM. A computer's main memory is RAM. See *RAM*, *ROM*.

microprocessor — See *central processing unit (CPU)*.

MIDI (Musical Instrument Digital Interface) — A standard for connecting musical instruments, synthesizers, and computers. The MIDI standard provides a way of translating music into a form computers can use, and vice versa.

modem — Short for “modulator/demodulator.” A device that converts information from digital to analog and back to digital, enabling information to pass back and forth between digital computers and analog telephone lines.

motherboard — The main circuit board in the computer. It contains the processor, memory, and other primary components.

MS-DOS prompt — See *system prompt*.

multimedia — A combination of two or more media, such as sound, animation, and video in a computer program or presentation.

Musical Instrument Digital Interface — See MIDI.

N

network — A collection of computers and associated devices that are connected by communications facilities. A network allows you to share data and peripheral devices, such as printers, with other users and to exchange electronic mail.

non-interlaced — A method of refreshing a computer screen, in which each pixel of every line is refreshed as the electron beam scans across and down the screen. Compare *interlaced*.

non-system disk — A disk for storing programs and data that cannot be used to start the computer. Compare *system disk*.

O

online — Available through the computer. Online may refer to information being read from your own computer’s hard disk, such as online documentation or online help, or to information coming from another company on a company network or the Internet.

operating system — A set of programs that controls how the computer works. Examples of operating systems are Windows 98 Second Edition and Windows 2000.

P

palette — See *color palette*.

parallel — Processes that occur simultaneously. In communications, it means the transmission of more than one bit of information at a time. On your computer, the parallel port provides a parallel communications interface between the computer and an appropriate device. Most modern printers are parallel. Compare *serial*.

password — A unique string of characters entered by a user to verify his or her identity to the computer or the network.

PC Card — A credit-card-sized expansion card designed to increase the capabilities of notebook computers. PC Cards provide functions such as modem, fax/modem, hard disk drive, network adapter, sound card, or SCSI adapter.

peripheral — Any device, such as a printer or joystick, that is attached to the computer and controlled by the computer's CPU.

pixel — Short for "picture element." The smallest dot that can be produced on a screen or printer.

Plug and Play — Generally, refers to the computer's ability to automatically configure itself to work with peripheral devices. When capitalized, refers to a standard that, when followed by a device manufacturer, allows a PC to configure itself automatically to work with the device.

pointing device — Any device, such as the AccuPoint or a mouse, that enables you to move the cursor on the screen.

port — A socket on the computer where you plug in a cable for connection to a network or a peripheral device.

processor — See *central processing unit (CPU)*.

program — A set of instructions that can be executed by a computer. The general classes of programs (also called software) are operating system, application, and utility. See also *operating system*, *application*, *utility*.

properties — The attributes of an object or device. For example, the properties of a file include the file's type, size, and creation date.

R

RAM (random access memory) — Volatile memory that can be written to as well as read. By volatile, we mean that information in RAM is lost when you turn off your computer. This type of memory is used for your computer's main memory. See also *memory*. Compare *ROM*.

random access memory — See *RAM*.

read-only memory — See *ROM*.

reboot — See *boot, restart*.

removable disk — A disk that can be removed from a disk drive. A diskette is one example of a removable disk.

resolution — A measure of the sharpness of the images that can be produced by a printer or displayed on a screen. For a printer, resolution is expressed in dots per inch (dpi). For a screen, it is expressed as the number of pixels available horizontally and vertically.

restart — Synonymous with reboot. To reset the computer by reloading the operating system without turning the computer off. See also *boot*.

RJ11 — A modular connector used on most U.S. telephone systems and direct-connect modems. The RJ11 connector is a 6-wire connector.

ROM (read-only memory) — Non-volatile memory that can be read but not written to. By non-volatile, we mean that information in ROM remains whether or not the computer is receiving power. This type of memory is used to store your computer's BIOS, which is essential instructions the computer reads when you start it up. See also *BIOS, memory*. Compare *RAM*.

S

select — To highlight or otherwise specify text, data, or graphics with the intent to perform some operation on it.

serial — Processes that occur one at a time. In communications, it means the transmission of one bit at a time sequentially over a single channel. On your computer, the serial port provides a serial interface between the computer and an appropriate device. Compare *parallel*.

shortcut — See *keyboard shortcut*.

software — See *program*. Compare *hardware*.

Standby — A feature of some Windows operating systems that allows you to turn off the computer without exiting your open applications and to continue from where you left off when you turn the computer on again.

Suspend — A feature of some Windows operating systems that allows you to turn off the computer without exiting your open applications and to continue from where you left off when you turn the computer on again.

system disk — A diskette that contains the operating system files needed to start the computer. Any diskette can be formatted as a system disk. A system disk is also called a “bootable disk” or a “startup disk.” Compare *non-system disk*.

system prompt — The symbol (in MS-DOS, generally a drive letter followed by a “greater than” sign) indicating where users are to enter commands.

T U

TFT display — See *active-matrix display*.

universal serial bus (USB) — A serial bus that supports a data transfer rate of up to 12 Mbps (12 million bits per second). USB can connect up to 127 peripheral devices through a single all-purpose USB port. USB allows hot swapping of peripherals. See also *bus*, *hot swapping*, *serial*.

upload — To send a file to another computer through a modem or network. See also *download*.

USB — See *universal serial bus (USB)*.

utility — A computer program designed to perform a narrowly focused operation or solve a specific problem. Utilities are often related to computer system management.

W

Web — See *World Wide Web*.

Wi-Fi — A trademarked term by the Wireless Capability Ethernet Alliance which stands for Wireless Fidelity. Wi-Fi is another term for the IEEE 802.11b communication protocol to permit an Ethernet connection using wireless communication components.

World Wide Web (www) — The worldwide network of Web sites linked together over the Internet. A user of the Web can jump from site to site regardless of the location of the computer hosting the site. See also *Internet*.

Index

A

- AC adapter 51
- AC power light 34, 51, 55
- Accessories programs 111, 125
- AccuPoint II
 - cleaning 201
 - control buttons 33, 56
 - not working 187
 - pointing device 33, 56, 104
 - using 103
- Active Desktop 133
- adding
 - background to a window 137
 - memory 47
- alarms
 - low battery 95, 96
- Application Launch 141
- Ask IRIS Online 220
- audio CDs
 - playing 37, 74, 77
- audio features 156

- avoiding injury 42

B

- battery
 - alarms 95
 - changing 96
 - charge not lasting 200
 - charging 53, 61, 92
 - conserving power 94
 - disposal 97
 - installing 96
 - light 34, 55, 93
 - Li-ion (lithium ion) 90
 - monitoring power 93
 - not charging 199
 - remaining power 93
 - removing 96
 - RTC (real-time clock) 90, 92
 - safety precautions 90
 - setting alarms 96
- battery cover 38
 - latch 39

Bootlog.txt file 190

browser 108

buttons

- AccuPoint II 33, 56

- CD controls 76

- CD or DVD controls 33, 35,
74, 76, 79

- CD Player 80

- DVD-ROM drive eject 75

- next track 36

- PC Card eject 31

- play/pause 35

- power 32

- previous track 35

- programmable 141

- Start 101

- stop 35

C

calculator 116

caps lock light 34

Card and Socket Services 159

CD and DVDs

- caring for 82

- inserting 78

- removing 81

- viewing contents 81

CD or DVD control buttons 33,
35, 74, 76, 79

CD Player control panel 80

CD/DVD/Media Player switch
33, 77

CD-ROM drive 74

CDs 33

- inserting 78

- problem solving 207

- using 74

channels

DMA 195

IRQ 195

Character Map 117

charging

- main battery 53, 61, 92

- RTC (real-time clock)
battery 92

classic style 135

cleaning

- AccuPoint II 201

- CD or DVDs 82

- computer 62

- diskettes 72

click 56

closing programs 116

COM port 146

- modem connection 146

comfort

- chair 43

- lighting 44

- work habits 45

commands

- Hibernation 85

- powering down 84

- Shut down 84

- Standby 85

communications

- cable-free 30

- network connection 143

- ports 146

- programs 83

- setting up 82

- system resources 194

- via modem 83

compact discs

- inserting 78

- problem solving 207
- removing 81
- computer
 - cleaning 62
 - lock 63
 - moving 63
 - non-system disk or disk
 - error message 188
 - not accessing disk drives 188
 - placement 42
 - protection 41
 - running on battery power 90
 - setting up 46, 47, 57
 - startup files 192
 - transferring information 144
 - turning off 130
 - turning on 55
 - using at the office 140
 - warning resume failure message 188
 - will not restart 201
 - work area 41
- computing tips 65
- connecting
 - AC adapter 51
 - external monitor 140
 - external speakers 158
 - headphones 158
 - modem 83
 - mouse 50
 - power cable 53
 - printer 50
 - to a network 83
 - USB mouse 50
- conserving battery power 94
- Contents
 - CDs 81
 - DVDs 81
 - cooling vents
 - CPU 29, 31
 - cursor control mode light 34
 - custom style 135
 - customizing
 - taskbar 132
 - window toolbars 137
- D**
 - date and time
 - setting 122
 - Date/Time icon 122
 - DC-IN jack 52
 - desktop 100
 - browsing style 134
 - choosing style and browsing options 136
 - classic style 135
 - creating new icon 100
 - creating shortcuts 116
 - custom style 135
 - major features 100
 - properties 120
 - shortcut menu 104
 - shortcut tray 102
 - Start button 101
 - styles 134
 - system tray 102
 - taskbar 102, 113
 - Web style 135, 137
 - Device Manager 196
 - checking properties 197
 - disabling a device 196
 - dial-up connection 84
 - Dial-Up Networking Wizard 84

- Digital Subscriber Lines (DSL) 146
 - Digital Versatile Discs 74
 - DirectShow 209
 - DirectX Foundation 209
 - Disk Defragmenter 205
 - disk drive
 - corrupted/damaged data
 - files 205
 - missing files/trouble
 - accessing a disk 204
 - running slow 205
 - diskette drive 72
 - can't insert a diskette 205
 - can't read a diskette 206
 - diskettes
 - caring for 72
 - cleaning 72
 - copying files to 73
 - inserting and removing 72
 - display
 - doesn't look normal/flickers 203
 - external monitor not working 204
 - latch 54
 - properties 121
 - screen is blank 202
 - display modes
 - changing 228
 - display panel
 - opening 54
 - displaying folder information 139
 - disposing of used batteries 97
 - DMA (Direct Memory Access) 195
 - check settings 207
 - double-click 56
 - DVD player
 - playing DVDs 163
 - DVD-ROM drive
 - can't access disc 206
 - drive tray won't open 206
 - eject button 75
 - inserting a disc 77
 - playing
 - CDs and DVDs 74
 - removing a disc 81
 - safety instructions 10
 - DVD-ROM/CD-RW drive 74
 - DVDs 33, 74
- ## E
- email 149
 - emulating a full-size keyboard 162
 - energy saving features 89
 - Energy Star Program 89
 - environmental considerations 42, 43
 - ergonomics
 - lighting 44
 - posture 43
 - seating guidelines 43
 - work habits 45
 - error messages
 - device driver conflict 194
 - general hardware problem 194
 - non-system disk or disk error 188, 205

- problem with display
 - settings/current
 - settings not working
 - with hardware 203
- program has performed an illegal operation 186
- warning resume failure 188
- WinDVD 210
- Ethernet 10/100 Ethernet LAN adapter 83
- Ethernet LAN Port
 - disabling 142
 - using 142
- expansion memory slot 48
 - cover 38
- external microphone
 - connecting 157
- external monitor
 - connecting 140
 - not working 204
- external speakers 158
- Ez Button 141
- F**
- FAT (File Allocation Table) 204
- fax 152
- faxing a document 151
- File Allocation Table (FAT) 204
- files 103
 - backing up 66, 73
 - Bootlog.txt 190
 - copying to diskette 73
 - printing 71
 - saving 65, 70
 - System.ini 192
 - transferring 144
 - Win.ini 192
- Fn key 33, 162
- folders 103
 - displaying information 139
- FreedomWare 101
- front panel 33
- function keys 33, 67
- H**
- hard disk drive
 - light 35, 55
- hardware conflicts 194
 - resolving 196
- headphone jack 32, 158
- headphones
 - connecting 158
- Help 126, 193
- Hibernation 85
 - low battery 95
 - restarting 87
 - using 87
- Hibernation mode 62
- hiding windows 112
- hot keys
 - display modes 228
 - instant password 227
 - keyboard functions 228
 - sound 228
- hot swapping 159
 - precautions 161
- HTML (Hypertext Markup Language) 135
- Hypertext Transfer Protocol (HTTP) 148
- I**
- icon 100
 - Date/Time 122
 - desktop 100
 - moving to desktop 100

- My Computer 100
 - naming 110
 - safety 24
- indicator light
 - Wi-Fi 36
- indicator panel
 - keyboard 34
 - system 33, 34
- infrared port 30
- inserting
 - CDs and DVDs 78
 - PC Cards 160
- installing
 - main battery 96
 - memory modules 47
- Internal/External mode 204
- Internet 148
 - bookmarked site not found 193
 - browser 108
 - chat rooms 149
 - connecting to 145
 - downloading files 150
 - news groups 149
 - overview 148
 - slow connection 192
 - uploading files 150
 - URL address not found 192
- Internet Connection Wizard 107
- Internet Explorer 101, 107
- Internet Service Provider (ISP) 147
- IRQ (Interrupt Request) 195

J

- jacks
 - headphone 32
 - microphone 32

K

- keyboard 33
 - character keys 67
 - Ctrl, Fn, and Alt keys 67
 - cursor control overlay 69
 - emulating full-size 162
 - function keys 67
 - hot keys 228
 - indicator panel 34
 - not working 187, 200
 - numeric keypad overlay 69
 - overlay keys 68
 - unexpected characters 200
 - Windows special keys 68

L

- LAN (Local Area Network)
 - adapter 83
 - port 30
- lights
 - AC power 34, 51, 55
 - battery 34, 55, 93
 - caps lock 34
 - cursor control mode 34
 - diskette activity 72
 - hard disk drive 35, 55
 - numeric mode 34
 - on/off 34
 - system 33
 - Wi-Fi 36

- lock slot 30
- Logged (Bootlog.txt) 190

M

- main battery
 - changing 96
 - maximizing battery life 91
 - removing 96

- memory
 - adding 47
 - problem solving 198
 - removing 50
 - removing expansion slot
 - cover 48
- memory module
 - inserting 49
 - removing 50
- microphone jack 32
- Microsoft Internet Explorer 83
- Microsoft Support Online Web site 193
- Microsoft Windows Millennium Edition 99
- minimizing 114
- modem
 - determining the COM port 146
 - FCC requirements 4
 - port 30, 83
 - problem solving 218
- modem, using 83
- modes
 - Safe 190
- monitor
 - connecting 140
 - not working 202
 - port 30
- mouse
 - connecting 50
- moving the computer 63
- My Computer 103, 104
 - icon 100
- My Documents icon 100
- N**
- network
 - accessing 143
 - connecting to 83
 - dial-up connection 84
 - Dial-Up Networking Wizard 143
- New Folder icon 110
- new text document 108
- next track button 36
- Notepad 109
- numeric mode light 34
- O**
- object properties 120
- on/off light 34
- online tours 128
- P**
- Paint 111
- palm rest 33
- parallel port 30
- password
 - instant 227
- PC Card
 - Card and Socket Services 159
 - checklist 214
 - CIS (Card Information Structure) 214
 - computer stops working 215
 - eject button 31
 - errors 216
 - hot swapping fails 216
 - inserting 160
 - not recognized 216
 - problem solving 214, 215
 - removing 160
 - replacing 161
 - slots 30
 - using 159

- PCMCIA (Personal Computer Memory Card International Association) 159
- play/pause button 35
- playing
 - audio CDs 77
 - CDs and DVDs 77
- Plug and Play 195
- pointing device
 - AccuPoint II 33, 56, 104
- ports
 - communication 146
 - infrared 30
 - LAN 30
 - modem 30
 - monitor 30
 - parallel 30
 - S-video out 30
 - USB 29, 31
- power
 - cable 53
 - cable connectors 229
 - computer will not start 187
 - light 34
 - monitoring 93
 - on/off button 32
 - problem solving 198
- Power Management
 - powering down 84
- power off
 - guidelines 62
- power usage mode 95
- precautions 45
- Predefined Function 141
- presentations
 - viewing on television set 152
- previous track button 35
- primary button 56
- printer
 - Add Printer Wizard 58
 - connecting 50
 - problem solving 217, 218
- printing a file 71
- problem solving 193
 - AC power 199
 - accessing disk drives 188
 - AccuPoint II 201
 - not responding 187
 - Ask IRIS Online 220
 - battery charge doesn't last 200
 - battery not charging 199
 - can't access CD/DVD 206
 - can't insert diskette in drive 205
 - can't read a diskette 206
 - changing display properties 203
 - checking device properties 197
 - compact discs not running correctly 207
 - computer hangs when PC Card inserted 215
 - computer will not power up 187
 - contacting Toshiba 221
 - corrupted/damaged data files 205
 - Device Manager 196

- disabling a device 196
- disk drive is slow 205
- display is blank 202
- DVD-ROM
 - controls are gray 207
 - drive tray doesn't eject 206
 - not functioning properly 209
 - performance is poor 207, 208
 - Root or Title menu does not open 208
 - slow playback 208
 - video content poor 209
- enabling the USB-FDD
 - Legacy Emulation option 188
- external display not working 204
- external keyboard not working 200
- external monitor 202
- faulty memory 198
- hardware conflict 194, 195
- hardware conflict caused by legacy device 195
- Help 193
- high-pitched noise 213
- illegal operation 186
- Internet bookmarked site not found 193
- Internet connection is slow 192
- InTouch Center 220
- keyboard
 - locked and computer will not restart 201
 - not responding 187
 - produces unexpected characters 200
- missing files/trouble
 - accessing a disk 204
- modem not receiving or transmitting 218
- no sound 213
- non-system disk or disk error 188, 205
- PC Card 214
 - checklist 214
 - error occurs 216
 - hot swapping fails 216
 - not recognized 216
 - slots appear dead 215
- Plug and Play 195
- power and batteries 198
- printer 217, 218
- program not responding 185
- program not working
 - properly 205
- rebooting from a USB
 - diskette drive 188
- screen does not look right/flickers 203
- system resources 194
- trouble prevention 218
- URL address not found 192
- using Startup options 189
- VirtualTech 220
- warning resume failure 188
- Windows Millennium
 - Edition not working 188

- Windows won't start 188
- WinDVD error messages 210
- programmable buttons 141
- programs
 - closing 116
 - not running correctly 205
 - starting 70
 - Web browsers 148
- properties 120

R

- recharging
 - main battery 92
 - RTC battery 92
- recording
 - adjusting quality 158
 - sounds 156, 157
- Recovery and Configuration Builder CD 25
- Recycle Bin 101, 123
- region code 173
- remaining battery power 93
- removing
 - CDs and DVDs 81
 - main battery 96
 - PC Cards 160
- resizing windows 112, 115
- restarting from Hibernation 87
- restarting from Shut down 87
- restarting from Standby 88
- RingCentral 152
 - sending a fax 152
- RTC (real-time clock) battery 90
- running the computer on battery power 90

S

- Safe mode 190

- safety
 - battery 90
 - computer 97
 - disposing of batteries 97
 - icons 24
 - precautions 45
 - saving your work 70
- ScanDisk 204
- screen
 - blank 202
 - doesn't look normal/flickers 203
- Screen Saver tab 121
- Search Engine 149
- secondary button 57
- security
 - fitting a computer lock cable 63
 - instant password 227
 - lock slot 30
- SelectServ 26
- sending a fax 152
- setting
 - battery alarms 95
- setting up
 - AC adapter 51
 - communications 82
 - computer 41, 46, 47, 57, 58
 - date and time 122
 - printer 58
 - software 57
- shortcut
 - creating 116
 - menu 104
 - tray 102

- Shut Down 62
 - Shut down 84
 - restarting 87
 - using 86
 - software
 - setting up 57
 - sound
 - .wav files 157
 - problem solving 213
 - SPANworks 150
 - speakers
 - external 158
 - Standby 85
 - command 62
 - low battery 95
 - mode 34
 - restarting 88
 - using 88
 - Start button 101
 - starting a program 70
 - Startup menu
 - Logged (Bootlog.txt) 190
 - Normal mode 189
 - problem solving 189
 - Safe mode 190
 - Step-by-step confirmation 191
 - stop button 35
 - support for Windows 102
 - S-video out port 30
 - switch
 - Wi-Fi 36
 - system indicator panel 33, 34
 - system requirements
 - WinDVD 209
 - System Restore 125
 - System Setup 188
 - System Tools 125
 - system tray 102
- T**
- taskbar 102, 113
 - customizing 132
 - telephone line
 - connecting the modem 83
 - text file 108
 - tips on computing 65
 - toolbars
 - customizing 137
 - displaying in a window 139
 - Toshiba
 - Accessories Information 25
 - Forum 222
 - Internet Web sites 222
 - online services 222
 - software offer 101
 - worldwide offices 223
 - trademarks 13
 - transferring files 144
 - transferring information between computers 144
 - traveling tips 97
 - troubleshooters 193
 - turning computer on/off 32, 55, 62
 - tutorials 106, 128
- U**
- Uniform Resource Locator (URL) 108, 132, 149
 - URL (Uniform Resource Locator) 132, 149
 - USB (Universal Serial Bus) port 29, 31
 - USB mouse
 - connecting 50

USB-FDD Legacy Emulation
option 188

Using

VirtualTech, Virtual Tech
101

using

Hibernation 87

modem 83

PC Cards 159

Shut down 86

Standby 88

Using VirtualTech 101

V

video features

exploring 152

VideoCDs

playing 156

VirtualTech 185

using 220

volume, adjusting 159

volume, adjusting alarm 228

W

warranty

SelectServ 26

wav files

recording 157

Web address 149

Web browsers 148

Web sites 221

Support Online 193

Web sites, Toshiba 222

Web style 135, 137

Wi-Fi

indicator light 36

on/off switch 36

wireless networking 142

windows

adding a background 137

hiding 112

repositioning 112

resizing 112, 115

Windows Explorer 111

Windows Help 102

Windows Media Player 33, 79

Windows Millennium Edition

Briefcase 144

change date and time

settings 122

changing the screen saver

120

closing programs 116

creating a new folder 110

creating a text file 108

creating shortcuts 116

desktop 100

Help 126, 193, 194

problem solving 188

Recycle Bin 123

removing objects 123

resizing or moving windows

113, 115

Shut Down 130

special features 131

starting programs 111

System Restore 125

tours and tutorials 128

troubleshooters 193

Web Tutorial 106

WinDVD 77, 163

advanced features 177

color balance 183

control panel 166

controls are disabled 207

customizing 172

-
- error messages 210
 - help 184
 - Internet browser, launching 184
 - not functioning properly 209
 - pan 183
 - performance is poor 207, 208
 - playing DVDs 163
 - playlists 170
 - properties, audio 174
 - properties, display 176
 - region codes 173
 - Root or Title menu does not open 208
 - slow playback 208
 - starting 164
 - status bar 165
 - system requirements 209
 - toolbar 165
 - video content poor 209
 - video window, maximizing 169
 - zoom 182, 183
- WinDVD 2000 156
- wireless networking 142
- Wizards
- Add Printer 58
 - Dial-Up Networking Wizard 143
 - Windows Me PC Card 214
- World Wide Web 148

— Blank Page —